

Newsletter

Year **16** n°4

Winter 2019

**Using CAE simulation
to verify the structural
safety and performance
of a two-wheeler's
driving mechanism**



Acoustic assessment of an electric water pump using ANSYS Workbench and Multiphysics simulation



A CFD simulation of melting furnace for the production of stone wool



CFD study to optimize the cooling performance of a narrow specialty tractor



EnginSoft Training Center

Drive Your Career!

Dive into our 2020 full training offer!

www.enginsoft.com/training



 **ENGINSOFT**

Flash

A McKinsey Global Survey on digital transformations conducted last year found that digital transformation in more traditional industries, such as oil and gas, automotive, infrastructure, and pharmaceuticals are more challenging than they are in other industries. The same study found that the greater the number of technologies adopted, the more successful the transformation was. Most companies in 2018 were using four of the following eleven technologies that McKinsey Global asked about: traditional web technologies, cloud based services, mobile internet technologies, big data and big data architecture, internet of things, design thinking, artificial intelligence tools, robotic, deep learning, augmented learning, additive manufacturing. (See the full report here: <https://www.mckinsey.com/business-functions/organization/our-insights/unlocking-success-in-digital-transformations>)

This is one of the factors that led the organizers of the International CAE Conference and exhibition to select digital transformation as the theme for this year's event. More specifically, the annual conference and this year's new exhibition focused on "The engineering simulation path to digital transformation" and illustrated how engineering simulation can be used in different productive contexts to orchestrate a successful and considered path towards effective digital transformation. In addition to the rich conference program, which included over 100 speakers in more than 20 conference sessions, this year's independent exhibition focused on the technologies, service providers and applications mentioned in the McKinsey's study, in addition to many others that are related to the digital transformation of businesses as they move towards Industry 4.0.

While the implementations may differ, digital transformation cannot be avoided, or a company risks progressive marginalization (if not exclusion) by the market and, ultimately, failure. In addition to the specific enabling technologies

of digital transformation, it is the inter-relationships between those technologies, as well as the related human factors that are the key to any effective and balanced digital transformation. The business risk of digital transformation has business executives worried. The operational challenges specifically are the major cause of concern, according to research conducted by North Carolina State University's Enterprise Risk Management Initiative and the US-based management consulting firm Protiviti Inc. The main headaches for business managers are existing operations and legacy technology infrastructure that impede rapid enough transformation to compete with natively digital organizations, while the feasibility and flexibility of business models to respond to customer demand, and then human resources issues, such as resistance to change and lack of access to skilled resources are important factors. For more information, see the article in the Harvard Business Review here: <https://hbr.org/2019/03/digital-transformation-is-not-about-technology>

The 2019 CAE Conference and Exhibition attracted around 1,500 delegates from Europe, the Middle East, Asia, the USA and Africa and over 70 exhibitors and sponsors from different industry sectors participated. NAFEMS and SIMAI endorsed the event in addition to running various sessions, while there were also events by APRE and SACT.

A highlight of the event that attracted a lot of media attention was the Round Table session "Cielo, terra mare" (Sky, Earth, Sea) hosted by outstanding female engineers which discussed ways to attract more girls and women to the STEM subjects and the engineering disciplines in general. This event was opened by

This final edition of the EnginSoft Newsletter for 2019 has collected some of the interesting technical papers and case studies that were presented at this year's conference, in addition to a selection of the winning Posters from the poster awards, and some of the projects featured in the Research Agorà. It is all fascinating reading.

At this point, I would like to wish you and your families everything of the best over the festive season and a successful and prosperous 2020.

Stefano Odorizzi,
Editor in Chief

Contents

Case Studies



6 Acoustic assessment of an electric water pump using ANSYS Workbench and Multiphysics simulation
by Pierburg Pump Technology



10 Industrial Sheet Metal Processing Company
by Salvagnini



12 Using CAE simulation to verify the structural safety and performance of a two-wheeler's driving mechanism
by Piaggio & C.



15 A CFD simulation of melting furnace for the production of stone wool
by Gamma Meccanica



18 CFD study to optimize the cooling performance of a narrow specialty tractor
by Argo Tractors



22 A method to conduct dynamic analyses of floating solar structures using AQWA
by Taesung S&E



24 IVECO S-WAY truck: perfecting cab design to maximize driving comfort
by IVECO



26 Comparing the performance and results of different FEM solvers
by Industrie Saleri Italo



30 The impact of numerical analysis on the efficiency of cooker hood ventilation systems
by Faber

Research & Technology Transfer



58 Growing life outside planet Earth

Software Updates

61 ANSYS Fluent and Particleworks air-liquid coupling simulation is available now

Events

62 Digital Twins support the security management of Critical Infrastructures

35th International CAE Conference SPECIAL SUPPLEMENT

- 33** 35th International CAE Conference: Themed around SBES and Digital Transformation, attracts 1,500 High-Level Engineers
- 35** Effectively digitalizing businesses
- 38** International CAE Conference Round Table on women in engineering makes waves

Poster Award 2019

- 41** The 2019 International CAE Conference Poster Awards
- 42** Design workflow for Additive Manufacturing
- 44** The Swiss AA-CAES pilot plant
- 46** Great Statues and Seismic Vulnerability

Research Agorà 2019

- 48** The Research Agorà at the 2019 CAE Conference
- 48** The quest to find a next-generation ADAS Simulation Framework
- 50** ODIN - CAD/CAE Integration in Orthodontic Device Innovation
- 51** POP = Performance Optimisation and Productivity - A Centre of Excellence in HPC
- 52** Hybrid manufacturing strategies through Selective Laser Sintering for the customization of series components
- 53** SmartBench – a SMART Industrial Safety WorkBENCH
- 54** WeldGalaxy – B2B Knowledge-based online platform for the Arc Welding Sector
- 56** Intelligent automatic and reconfigurable robots for quality control
- 57** Three big projects for SME Innovation

Newsletter EnginSoft Year 16 n°4 - Winter 2019

To receive a free copy of the next EnginSoft Newsletters, please contact our Marketing office at: info@enginsoft.it

All pictures are protected by copyright. Any reproduction of these pictures in any media and by any means is forbidden unless written authorization by EnginSoft has been obtained beforehand. ©Copyright EnginSoft Newsletter.

EnginSoft S.p.A.

24126 BERGAMO c/o Parco Scientifico Tecnologico
Kilometro Rosso - Edificio A1, Via Stezzano 87
Tel. +39 035 368711 • Fax +39 0461 979215
50127 FIRENZE Via Panciatichi, 40
Tel. +39 055 4376113 • Fax +39 0461 979216
35129 PADOVA Via Giambellino, 7
Tel. +39 049 7705311 • Fax +39 0461 979217
72023 MESAGNE (BRINDISI) Via A. Murri, 2 - Z.I.
Tel. +39 0831 730194 • Fax +39 0461 979224
38123 TRENTO fraz. Mattarello - Via della Stazione, 27
Tel. +39 0461 915391 • Fax +39 0461 979201
10133 TORINO Corso Marconi, 10
Tel. +39 011 6525211 • Fax +39 0461 979218

www.enginsoft.com
e-mail: info@enginsoft.com

The EnginSoft Newsletter is a quarterly magazine published by EnginSoft SpA

COMPANY INTERESTS

EnginSoft GmbH - Germany
EnginSoft UK - United Kingdom
EnginSoft France - France
EnginSoft Nordic - Sweden
EnginSoft Turkey - Turkey
VSA-TTC3 - Germany
www.enginsoft.com

CONSORZIO TCN www.consorziotcn.it • www.improve.it
M3E Mathematical Methods and Models for Engineering www.m3eweb.it
AnteMotion

ASSOCIATION INTERESTS

NAFEMS International www.nafems.it • www.nafems.org
TechNet Alliance www.technet-alliance.com

ADVERTISING

For advertising opportunities, please contact our Marketing office at: info@enginsoft.com

RESPONSIBLE DIRECTOR

Stefano Odorizzi

PRINTING

Grafiche Dalpiaz - Trento

Autorizzazione del Tribunale di Trento
n° 1353 RS di data 2/4/2008

The EnginSoft Newsletter editions contain references to the following products which are trademarks or registered trademarks of their respective owners: ANSYS, ANSYS Workbench, AUTODYN, CFX, FLUENT, FORTE, SpaceClaim and any and all ANSYS, Inc. brand, product, service and feature names, logos and slogans are registered trademarks or trademarks of ANSYS, Inc. or its subsidiaries in the United States or other countries. [ICEM CFD is a trademark used by ANSYS, Inc. under license]. (www.ansys.com) - modeFRONTIER is a trademark of ESTECO Spa (www.esteco.com) - Flownex is a registered trademark of M-Tech Industrial - South Africa (www.flownex.com) - MAGMASOFT is a trademark of MAGMA GmbH (www.magma-soft.de) - FORGE, COLDFORM and FORGE Nxt are trademarks of Transvalor S.A. (www.transvalor.com) - LS-DYNA is a trademark of LSTC (www.lstc.com) - Cetol 6σ is a trademark of Sigmatrix L.L.C. (www.sigmatrix.com) - RecurDyn™ and MBD for ANSYS is a registered trademark of FunctionBay, Inc. (www.functionbay.org) Maplesoft are trademarks of Maplesoft™, a subsidiary of Cybernet Systems Co. Ltd. in Japan (www.maplesoft.com) - Particleworks is a trademark of Prometech Software, Inc. (www.prometechsoftware.com).

Acoustic assessment of an electric water pump using ANSYS Workbench and Multiphysics simulation

Feasibility study of a complete
acoustic workflow

By **Morena Angelucci**, Giuseppe Marulo, Raffaele Squarcini
Pierburg Pump Technology

This technical article describes an acoustic emissions study conducted on an electric water circulation pump used for supplementary cooling or heating functions in vehicles, by the Modeling & Simulation Pumps Department of Pierburg Pump Technology. This case study was used to demonstrate the feasibility of using a complete acoustic workflow, from the analysis of the main exciting loads to the acoustic output, which made it possible to quantify the relative contributions of the different loads to the final acoustic emission.

This article describes a study conducted by the Modeling & Simulation Pumps Department of Pierburg Pump Technology to investigate the acoustic emissions of an electrical water circulation pump.

The electronically commutated water circulation pump (WUP), shown in Fig. 1, is mainly used for supplementary cooling or heating functions such as:

- the removal of residual heat after the vehicle engine has been turned off (in connection with a radiator fan);
- to quickly warm up the interior of the vehicle, as part of the auxiliary heating systems;
- to support mechanical water circulation pumps in critical operating conditions (stop and go);
- to cool batteries and drives in electric vehicles.

Characterized by its small size and compactness, this pump can be easily mounted in different positions under the engine hood.



Fig. 1 - Electrical water circulation pump (WUP).

However, if the pump is installed close to the cabin, its sound emissions can be amplified and become an annoying noise for passengers.

For this reason, the possibility of having one or more tools to analyze the complexity of an acoustic problem, from its root cause(s) to its occurrence, is a considerable advantage – both to prevent a potential problem and to apply corrective modifications during the design phase.

This study investigated the sound generated by a WUP pump using multiphysics simulations in ANSYS Workbench. The case study was logically decomposed into its essential physical parts and analyzed using the single-physics blocks in ANSYS.

Then, the sub-models were linked to take into account the causality and interaction among the physics, and to finally study the component's vibro-acoustics.

Background

Vibro-acoustic phenomena are inherently a multiphysical issue: the structural vibration of a body generates pressure waves that propagate in the surrounding medium (e.g. air) generating sound. The vibration of the structure, in turn, is caused by exciting loads which can have different origins (fluid-dynamics, mechanical, electro-magnetic, etc.).

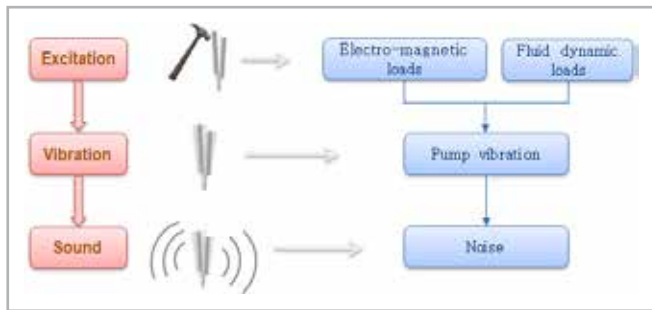

Fig. 2 - Schematic workflow of the acoustic phenomena and their application to the WUP pump.

In the Pierburg case study – the water circulation pump WUP – a brushless DC motor with electronic commutation drives the pump impeller. The fluid-dynamic pressure distribution acts on the wet surfaces of the pump housing and the impeller. Therefore, the general structure of the pump is excited by a combination of electromagnetic, fluid dynamic and mechanical loads, which cause its vibrations.

The vibration of the pump structure produces a series of pressure waves, which propagate through the surrounding medium and can be perceived as sound. Furthermore, the ultimate acoustic perception is influenced by the position of the receiving apparatus with respect to the source, and the characteristics of the surrounding environment. Fig. 2 shows the general logical scheme of vibro-acoustic phenomena and their application to our case study.

Multi-physics simulations

The test case was analyzed by deconstructing the problem into its basic physical elements and their interactions. Similarly, simulations were performed starting from single-physical blocks (e.g. CFD, electromagnetism) and then connected with causal connections within ANSYS Workbench.

Before going into the details of the modeling activity blocks, there is a brief description of the pump.

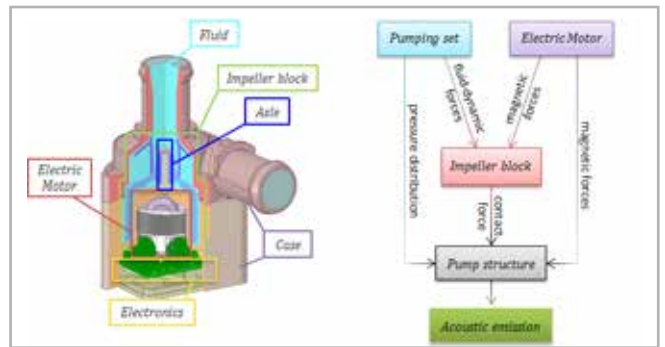

Fig. 3 - Sketch of the WUP pump and breakdown of the physical segments leading to the acoustic emissions.

Geometry and problem analysis

The main parts of the analyzed pump are sketched on the left side of Fig. 3. The electric motor is driven by electronic commutation. An external rotor is an integral part of the impeller, which rotates around a fixed shaft (axle). The fluid fills the impeller and the rotor cavity. All components are enclosed inside a plastic housing. The right side of Fig. 3 outlines the breakdown of the physical segments that characterize the origin of the acoustic emission. The fluid pumping set implies a certain pressure distribution on the wet walls of the rotor and the impeller, as well as on the pump structure (outer casing). In the meantime, electromagnetic forces act between the rotor block and the stator, which is connected to the pump structure. Therefore, the rotor-impeller block is subject to both fluid-dynamic and electro-magnetic forces. Due to a small axial and radial space between the axle and the housing, this component can beat the pump structure and transmit some contact forces to it. However, only the axial gap is considered in this study since it impacts the most in terms of loads. The vibration of the pump is caused by the above-mentioned loads on the structure and is responsible for the emission of noise into the surrounding environment.

Fluid-dynamics analysis

The first block of simulation is the computational fluid dynamics (CFD), analyzed with ANSYS Fluent. The CFD domain of the centrifugal pump is shown in Fig. 4. We studied the specific working point at a rotation speed of 3000 rpm using a transient simulation to study the temporal trend of the main fluid-dynamics parameters. One of the simulation outputs was the pressure distribution on the surfaces in contact with the pump housing over

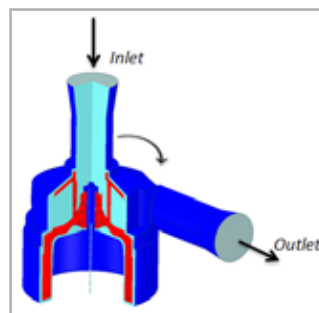

Fig. 4 - Computational domain of the fluid-dynamics simulation.

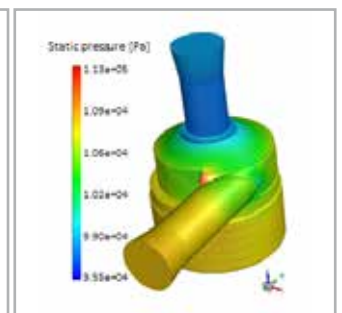

Fig. 5 - Pressure distribution on the fluid walls in contact with the pump housing at a specific time step.

■ CASE STUDIES

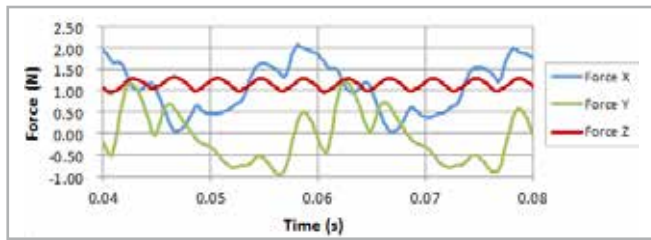

Fig. 6 - Total force acting on the rotor-impeller block due to fluid-dynamic pressure.

time, shown in blue in Fig. 4. The result at a specific time step of the transient simulation is reported in Fig. 5.

The time-variant of the total force acting on the rotor-impeller block (red surfaces depicted in Fig. 4) was also extrapolated from the Fluent simulation; the corresponding result is shown in Fig. 6. In addition, the average fluid-dynamic torque required was used as a reference value for the electromagnetic simulation.

Electromagnetic simulation

The electromagnetic simulation of the single-phase brushless (BLDC) motor was performed with Maxwell 3D with the aim of calculating the vertical forces on the rotor. A sketch of the computational domain for the electromagnetic calculations is shown in Fig. 7.

The main input of the simulation was the excitation current to the winding. A sinusoidal current form was chosen to simplify the problem and due to the lack of additional information. In addition, the minimum root mean square (RMS) value of the excitation current capable of generating the desired torque was chosen. Two main outputs were extracted from the simulation: the stator forces on the rotor (reported in Fig. 8) and the total loads (forces, torque) on the stator, which is connected to the pump housing.

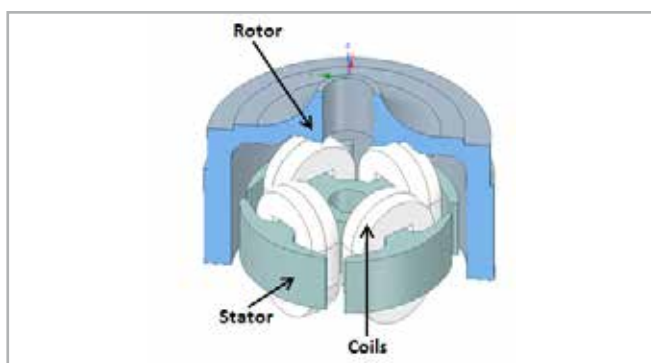

Fig. 7 - Computational domain of ANSYS Maxwell 3D electromagnetic simulation.

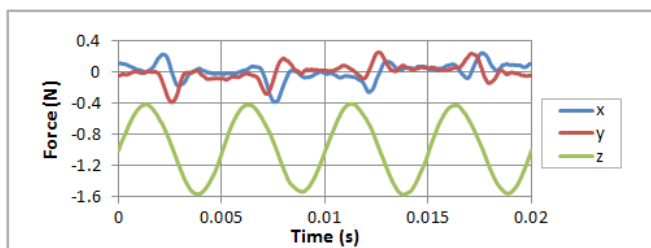

Fig. 8 - Time trend of the force components on the rotor during one rotation.

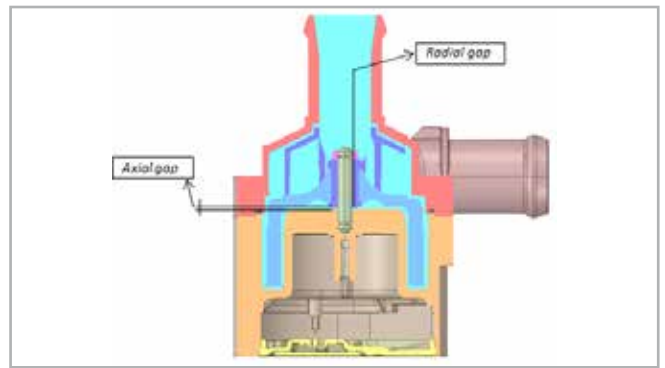

Fig. 9 - Axial and radial gaps between the rotating block and the shaft fixed to the housing.

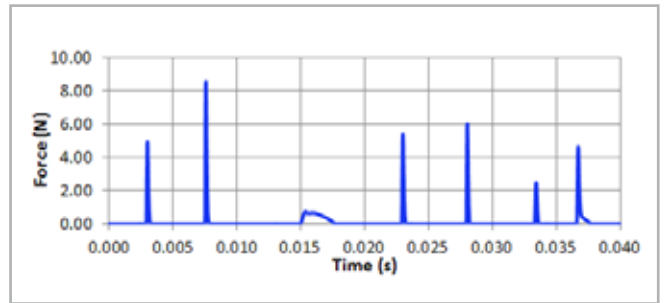

Fig. 10 - Contact force due to the impeller block beating against the pump structure.

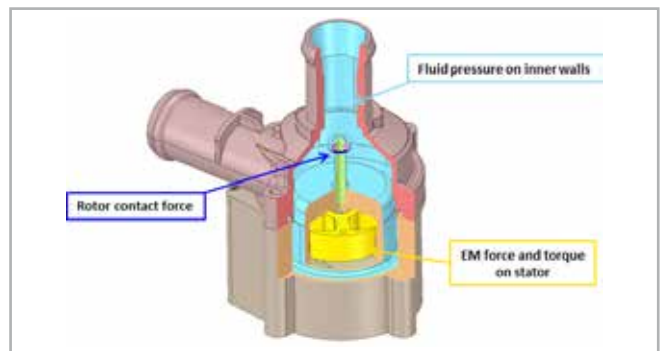

Fig. 11 - Main loads acting on the pump structure.

Multi-body simulation

The third block of analysis focused on the dynamics of the impeller-rotor block, to study the contact force of the block on the pump structure. In fact, there are axial and radial spaces between the rotating part and the shaft fixed to the housing, as shown in Fig. 9. As already mentioned, only axial dynamics were taken into consideration in this study.

The contact problem was studied using the Multibody software MSC ADAMS, in which the input of the calculation was the sum of the fluid-dynamic and electromagnetic forces (only of the vertical components), previously obtained with the CFD and Maxwell calculations.

The outputs of the Multibody calculations were the kinematics of the impeller block and the contact force of the block on the pump structure due to the impact between the two parts, shown in Fig. 10.

Multi-physics and vibro-acoustic analysis

All the loads acting on the pump structure, calculated in the previous steps, were used as input for the structural simulations,

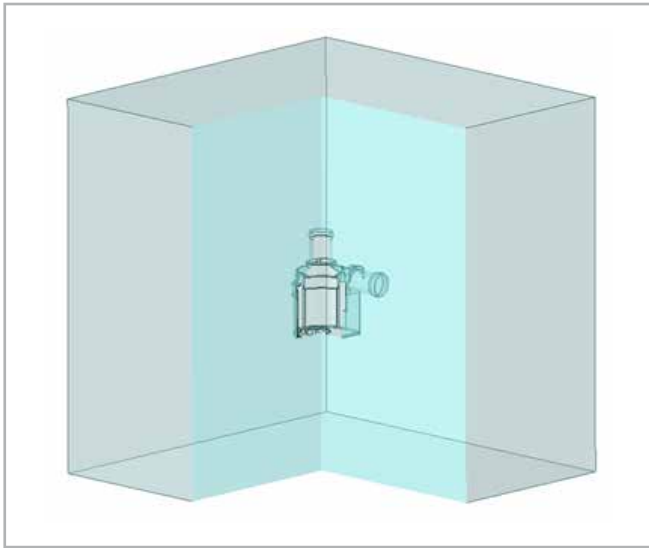

Fig. 12 - Acoustic domain (air) around the pump.

About Pierburg

A dedicated player in the process of transformation and an active part of societal change: for more than 100 years, Pierburg has been a driver of progress in the field of mobility – over and over again. As specialists for increasing efficiency, CO2 reduction, and lowering of emissions, the four Pierburg Business Units are solution providers, agents of change, and architects of sustainable mobility with a clear commitment to climate protection and cleaner air.

Fig. 14 shows the summary of the simulation workflow, which was the practical application of the theoretical breakdown shown in Fig. 3. This block diagram shows the segments of the single physics, the simulation tools used and their connections.

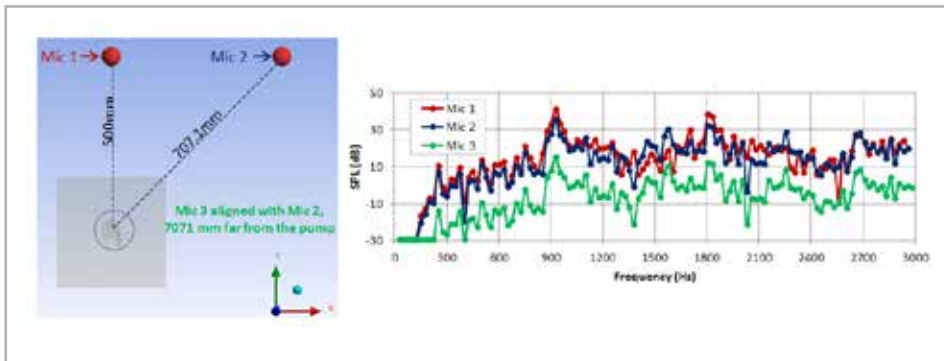

Fig. 13 - Sound pressure level of the virtual microphones for the acoustic simulation.

using the Harmonic Response block of ANSYS Workbench. Fig. 11 shows these loads: the distribution of the fluid-dynamic pressure on the walls (light blue), the electromagnetic loads on the stator (yellow), and the contact force due to the impact of the impeller block (dark blue).

The structural harmonic response was calculated to find the vibration of the pump (deformation, velocity and acceleration).

Finally, the acoustic emission due to the pump vibration was studied in ANSYS Harmonic Acoustics. The acoustic domain (Fig. 12) included only the medium for the propagation of sound waves (air), while the volume occupied by the pump is empty.

The speed of the pump's outer skin was transferred to the air domain as an input for the acoustic simulation. A free field condition was simulated at the boundaries of the acoustic domain.

One of the main post-processing outputs of the acoustic simulation was the sound pressure level (SPL) of the virtual microphones, which can also be positioned outside the acoustic domain. An example of the results obtained is shown in Fig. 13. The microphone output was then post-processed with external software to create an audio file in order to achieve a proper acoustic assessment.

Conclusions

The WUP case study was a successful example of demonstrating the feasibility of a complete acoustic workflow, from the analysis of the main exciting loads to the acoustic output. This approach made it possible to quantify the relative contribution of the different loads to the final acoustic emission. The ANSYS Workbench environment made this activity efficient due to the possibility

of establishing direct links between the different physics, which facilitated the transfer of data and results.

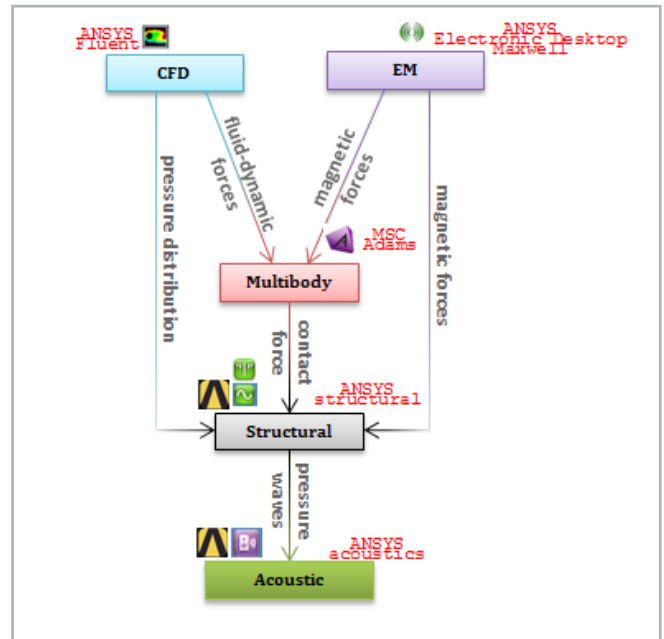

Fig. 14 - Simulation workflow developed for the WUP acoustic test case.

For more information
 Morena Angelucci - Pierburg Pump Technology
morena.angelucci@it.rheinmetall.com



Industrial Sheet Metal Processing Company

salvagnini

Salvagnini Chooses RecurDyn for Multibody Analyses

By **Davide Marini**
EnginSoft

With over 7,000 installations in 76 countries, the largest panel bender factory in the world, and more than 50 years of experience and expertise, Salvagnini is a reference in applying intelligence to sheet metal working and has selected RecurDyn software for its multibody analysis requirements, becoming the 500th commercial customer of FunctionBay Inc.

partners, EnginSoft, to assist us with a joint pilot project to carefully evaluate the capability of the RecurDyn software solution. This test period fully satisfied our needs, also thanks to the competence of EnginSoft's technical staff. For this reason, we decided to choose RecurDyn since it proved to be a good fit for our needs for performance and usability."

Giorgio Pilati, numerical simulation specialist in Salvagnini Italia's R&D department, explains, "Our objective was to improve the capabilities of our simulation systems, so we asked our

Salvagnini has been working in the field of flexible automation and industrial machinery for sheet metal working for more than fifty years. The company owns five production plants, and twenty-three offices dedicated to sales and customer service worldwide.

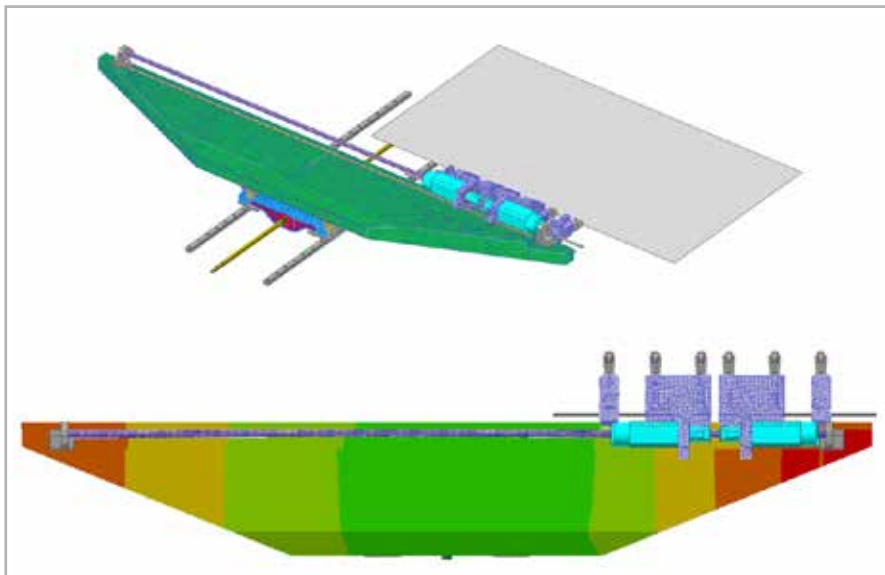

The forward-thinking spirit of the international Group, its innovative culture and pioneering technology are reflected in innovative solutions of high-quality, such as punching/shearing systems, combined machines, panel benders, press-brakes, fiber lasers, integrated FMS/FMC, automatic storage systems, Automatic Job Shops (AJS™) and IMAS integrated factories. The management of automated devices and proprietary software completes Salvagnini's Industry 4.0-compliant solutions.

Salvagnini's technical department uses state-of-the-art technologies not only for the processing phase (bending, cutting,

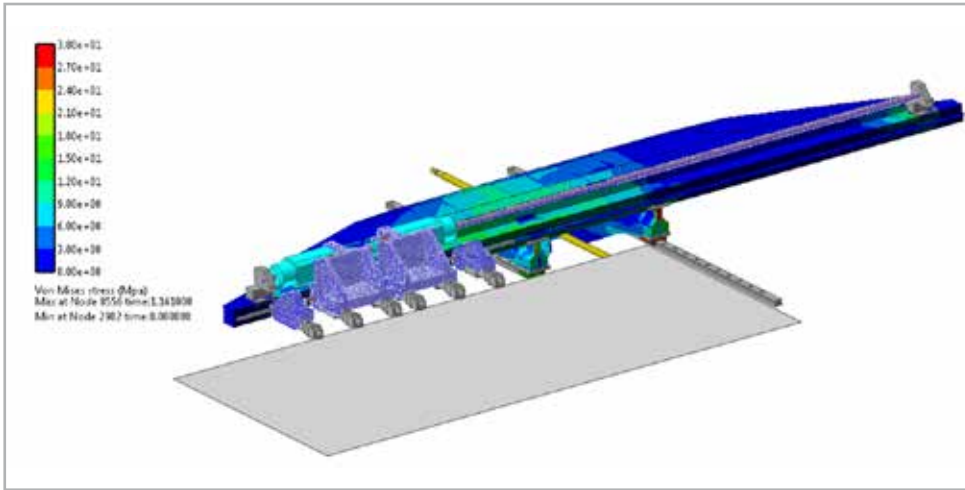

the flexibility of the entire machine is taken into account without the need for powerful HPC infrastructures and without any convergence problems. At the same time, the powerful RecurDyn expression editor is used to develop an analytical model that represents the interaction between the metal sheets and their supporting entities in terms of both frictional and viscous damping.”

In addition, Salvagnini has decided to acquire the RecurDyn Machine

punching), but also for the handling and moving operations, since the machines are fully automated to reduce risks for the operators. All the company’s products must satisfy two opposing requirements: handle large payloads with high precision while operating at high speed to increase the capacity of the machine.

In addition, the market is constantly demanding better-performing designs in terms of increased payloads, higher precision and shorter cycle times.

The design of the handling mechanisms must take into account the dynamic effects caused by the coupling of the inertial load with the structural flexibility. During acceleration and deceleration, the machine structure undergoes small deformations that can cause oscillations at the end of the movement, especially with higher payloads.

To achieve an excellent result during the processing operation, the metal sheets must have been accurately positioned in advance and they must be kept in position without any oscillation.

Fabiano Maggio, Chief Technology Officer at EnginSoft’s System Dynamics Team, explains, *“Multi-flexible-body simulation provides a robust tool for efficiently creating and analyzing virtual prototypes capable of reproducing the dynamic behavior of the machine under different operating conditions. In this way it is possible to compare different solutions during the early stages of design to single out the best one, reducing the need for physical prototypes. To perform these simulations Salvagnini has chosen to acquire RecurDyn, a best-in-class tool to perform multi-flexiblebody simulations.”*

Maggio continues, *“Thanks to the RecurDyn Reduced Flex approach,*

Toolkit, which allows the company to automatically create the features representing linear guides and ball screws.

Thanks to dedicated functions, the toolkit can be effectively used to represent the flexibility of these components and also to correctly represent their local interactions.

“We are confident that with the use of this tool we can accurately simulate multi-body analysis, and this will allow us to reduce product development time, enabling us to evaluate many more design alternatives, improve the quality and performance of our projects, and reduce costs,” Pilati adds.

He concludes: *“We are absolutely certain about our decision and that it will prove to be the best solution, in line with Salvagnini’s policy, which has always been to invest in the best technologies.”*

For more information
 Fabiano Maggio - EnginSoft
f.maggio@enginsoft.com



Using CAE simulation to verify the structural safety and performance of a two-wheeler's driving mechanism

Coupled simulation methods enables more accurate evaluation

by Riccardo Testi
Piaggio & C.

Social and environmental factors continue to drive demand for electric vehicles. In this article, we describe how Piaggio, which produces motorcycles and scooters including the world-renowned brands Aprilia, Moto Guzzi, Vespa and Piaggio, used computer-assisted engineering simulation to evaluate the structural safety, performance and dynamic behavior of the driving mechanism of a two-wheeled vehicle under both normal and spurious operating conditions, specifically static and fast dynamic conditions.

The driving mechanism studied was developed to move a two-wheeled vehicle backwards. The actuating system is mounted on the rear-wheel axle. The necessary torque is provided by an electric motor. Fig. 1 shows the multibody model used to predict the system's dynamic behavior. The simulacrum is a rigid body whose rotational inertia properties are equivalent to the vehicle's translational ones. The simulacrum was included in the simulation model to ensure the correct prediction of the system's response time. The largest gear on the left-hand side of Fig. 1 is coupled with the simulacrum by means of a cylindrical joint. So, when a torque is generated by the electric motor, the gear does not move the vehicle. Instead, the gear moves three rotating bodies, which are initially kept in place by springs, as shown in Fig. 2:

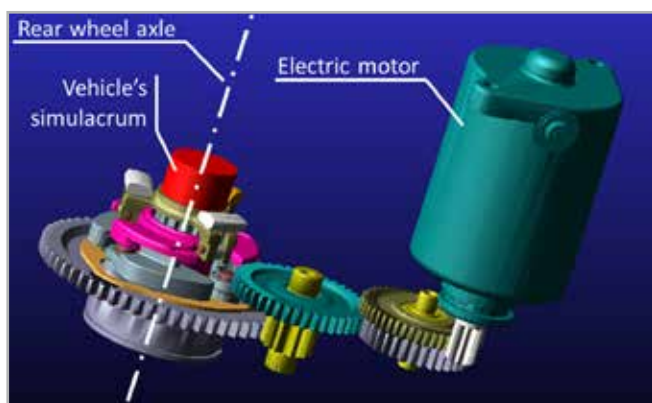

Fig. 1 - The multibody model.

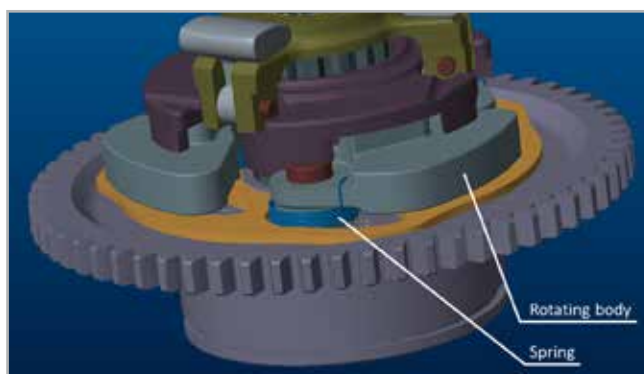

Fig. 2 - Rotating bodies.

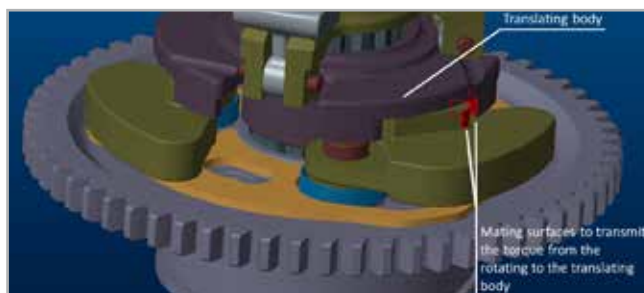

Fig. 3 - The interface between the rotating and the translating bodies.

The spring force is not sufficient to keep the rotating bodies in place when their angular velocity exceeds a certain value, due to the torque transmitted to the gear. So, the rotating bodies transition to the position illustrated in Fig. 3, which enables them to transmit the torque to the so-called "translating body":

The translating body is coupled with the wheel axle by means of a translational joint which allows the torque to be transmitted to the vehicle when the rotating and the translating bodies engage with each other. The engagement occurs with impact phenomena, which Piaggio studied to determine the structural resistance of the joint.

The system's functionality was evaluated by simulating the engagement process between the rotating and the translating bodies.

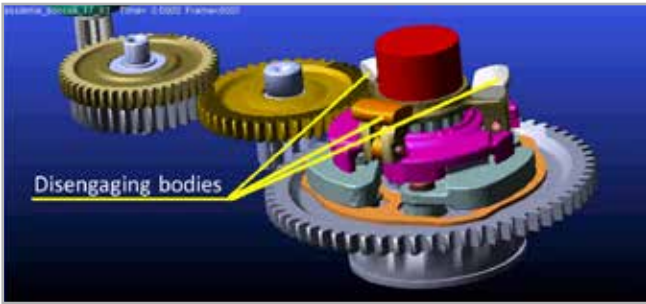

Fig. 4 - The disengaging bodies.

When the vehicle moves forward, spurious mating between the rotating and the translating bodies must be avoided, because the internal combustion engine (ICE) would make the electric motor rotate at a high enough speed to destroy it. Such spurious mating can be induced by a malfunction of the springs. To that end, the translating



Fig. 5 - Safe position during forward motion of the vehicle.

body can move away from the rotating ones as a result of the motion of three so-called “disengaging bodies” (see Fig. 4). When the vehicle moves forward, the disengaging bodies rotate, pushing the translating body away from the rotating ones, and up to a final, safe position where spurious engagements are not possible (see Fig. 5). A multibody model was used to compute the speed at which this mechanism reaches the safe position. That speed must be low enough to guarantee the electric motor’s survival.

These disengaging bodies undergo both impact conditions and high-speed stationary ones. Both these conditions were simulated to assess the structural resistance of the disengaging bodies.

Results

The vehicle’s backward motion

The first simulation concerned the electric motor that actuates the device; the simulation included:

- Phase 1: the electric motor is turned on until the vehicle reaches the desired backward velocity.
- Phase 2: the electric motor is turned off until the vehicle stops

The simulation was carried out under both lubricated and dry conditions. The graph in Fig. 6 shows the angular velocity of the simulacrum (see Fig. 1), which is, of course, directly related to the vehicle speed.

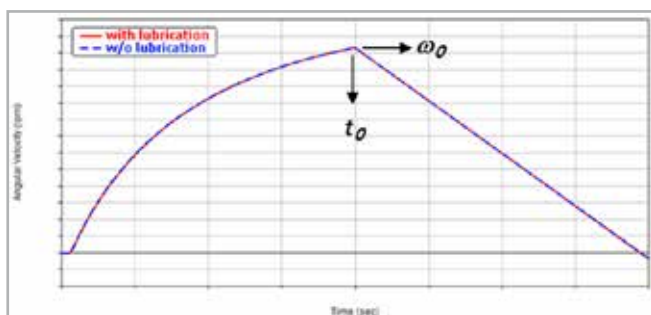

Fig. 6 - The vehicle’s backward speed.

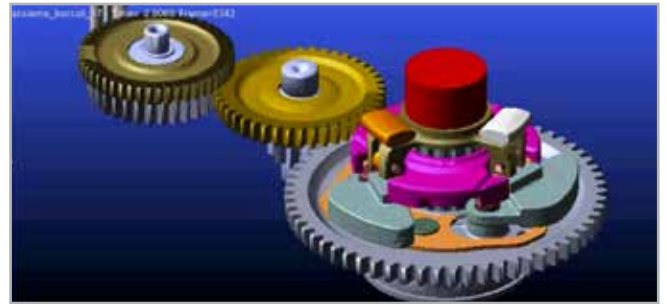

Fig. 7 - The system’s final stationary position subsequent to the vehicle’s backward motion.

ω_0 is the simulacrum’s angular velocity that corresponds to the desired backward speed of the vehicle. The relevant quantity to be computed was t_0 , which measured the system’s responsiveness: its computed value was deemed satisfactory.

Lubrication was discovered to be irrelevant in terms of vehicle backward speed. However, it proved to be necessary because the rotating and the translating bodies remain engaged after the vehicle stops, because the spring’s forces are insufficient to overcome the friction forces at the mating surfaces. Fig. 7 shows the system’s configuration after the vehicle had stopped, without lubrication:

Lubrication turned out to allow the rotating bodies to resume to their initial position after the vehicle stopped.

The disengaging process

The simulation was then carried out moving the vehicle forwards. This was simulated by applying a ramped angular velocity to the simulacrum.

The translating body’s motion along the rear-axle’s axis had to be triggered at a low enough vehicle speed to guarantee the electric motor’s survival.

Fig. 8 shows both the translating body’s axial position and the vehicle speed time histories.

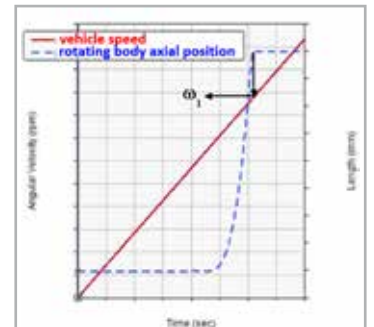

Fig. 8 - The disengaging process and the time history of the translating body’s position

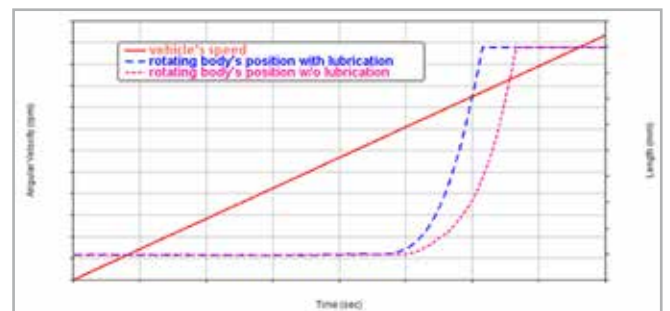

Fig. 9 - The disengaging process and the effect of lubrication.

ω_1 was deemed to be low enough to avoid failure of the electric motor. Lubrication turned out to have a significant effect on this working condition, as shown in Fig. 9.

As was expected, the lubricated systems was more responsive.

The disengaging bodies’ structural performance

Due to the system’s topology, the disengaging bodies experience the same angular velocity as the rear-wheel axle. So, they can reach

■ CASE STUDIES

the angular velocity that corresponds to the vehicle's maximum speed. A fixed element method (FEM) analysis was conducted to verify whether those bodies could withstand the maximum speed condition. Fig. 10 shows the computed stress distribution.

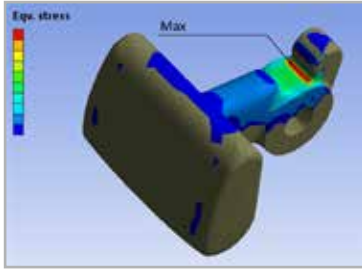

Fig. 10 - The disengaging bodies' structural performance and stress distribution under high-speed conditions.

The FEM analysis determined that the safety factor corresponding to the maximum stress was high enough to conform to the Piaggio standard. At the end of the disengaging process, when the translating body reaches its final position, the disengaging bodies are affected by the same impact condition that the translating body undergoes. Fig. 11 shows the system's initial and final positions.

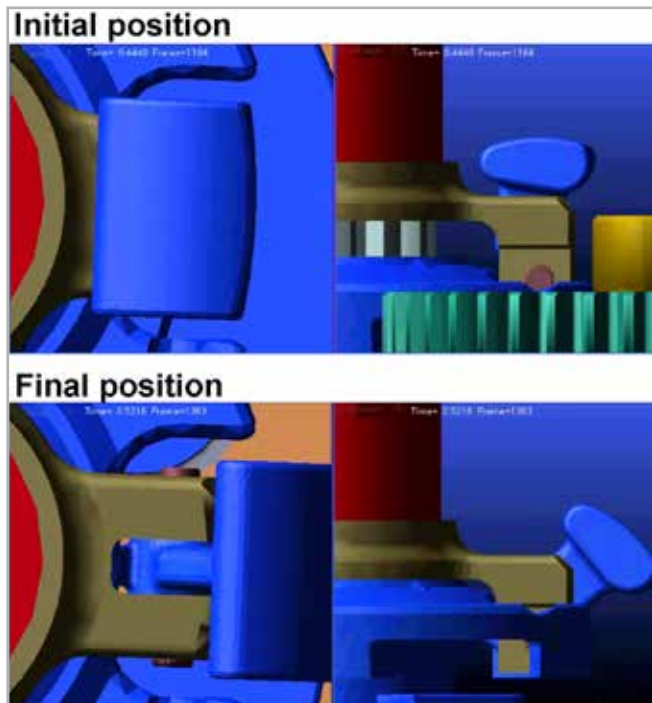

Fig. 11 - The disengaging bodies' structural performance and the initial and final positions of the transient condition.

Fig. 12 shows the stress distribution in a disengaging body when the translating body reaches its final position.

The maximum stress here was found to be at the same position as in the high-speed, stationary condition (see Fig. 10). The maximum value,

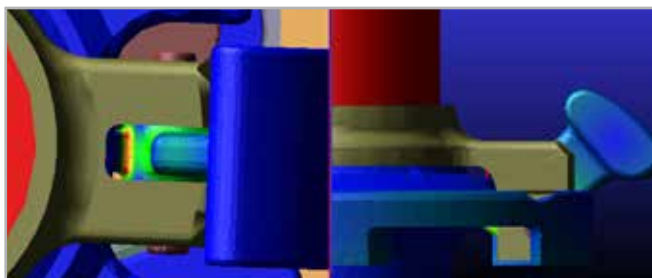

Fig. 12 - The disengaging bodies' structural performance and the stress distribution in the disengaging bodies during the transient condition.

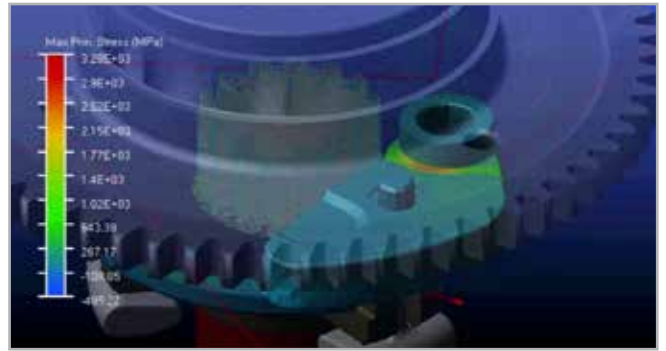

Fig. 13 - The rotating bodies' structural performance and the modal superposition results.

however, was revealed to be 10 times smaller in the stationary condition.

The rotating bodies' structural performance

The rotating bodies undergo impact conditions when they engage with the translating body. The resulting stress distribution was first evaluated using a modal superposition approach directly inside the multibody model. Using this method, stress levels were obtained which were above the yield limit, due to the method's inability to consider the material's plasticity:

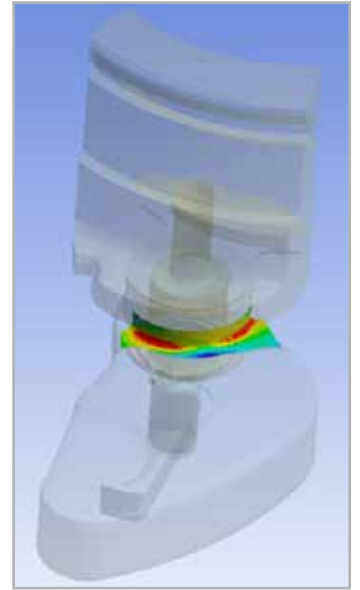

Fig. 14 - The rotating bodies' structural performance and the stress distribution computed with an explicit FEM model.

Therefore, the multibody model was used to compute the impacting bodies' velocities, which were subsequently fed to an explicit FEM model as the initial conditions. This latter model was then used to compute the stress state, using proper material data, to take into account the plasticity phenomena induced by high strain rates. Fig. 14 shows the stress distribution at time of impact.

The maximum stress was found to be below the maximum limit allowable by the Piaggio standard.

Conclusion

The dynamic behavior of the system was simulated, singling out the effects of lubrication and verifying its functionality under both normal and spurious working conditions.

The structural integrity of critical components was verified by leveraging coupled MBS/FEM analyses.

For more information
 Riccardo Testi - Piaggio & C.
riccardo.testi@piaggio.com

A CFD simulation of melting furnace for the production of stone wool

Simulation provides substantial information about the melter's operating conditions

Gamma Meccanica's R&D department is constantly researching new solutions to improve the overall performance of equipment, production capacity and reliability while developing environmentally sustainable processes and applications to benefit its customers.

The most recent example is the study of a new electric melter (see Fig. 1a). The company purchased the ANSYS Fluent software to perform a computational fluid dynamics (CFD) simulation of an electric melter for the fusion of basalt and dolomite rocks (see Fig. 1b).



Fig. 1 - Left - Electric melter. Right - Detail of the fusion of basalt and dolomite rocks.

The use of a mathematical model allows an in-depth understanding of the operation, optimizing the geometric characteristics such as the center-to-center spacing of electrodes or of their depth of immersion in the melt.

The CFD model

Gamma Meccanica conducted a CFD simulation on a 7 ton/h electric melter (see Fig. 2a).

The actual geometry was imported via a STEP in SPACECLAIM. Reasonable simplifications were applied to reduce the mesh size. The resulting geometry (Fig. 2b) was parameterized. Several geometric parameters are the subject of these studies:

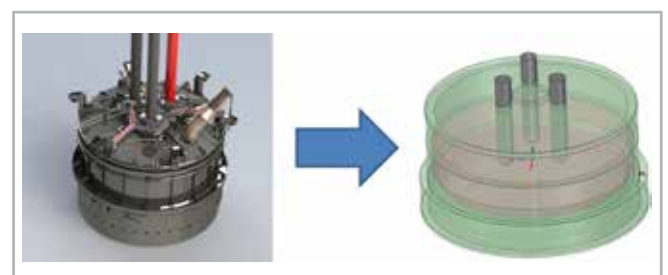

Fig. 2 - Left - Rendering of the electric melter. Right - Simplified 3D geometry in SpaceClaim

■ CASE STUDIES

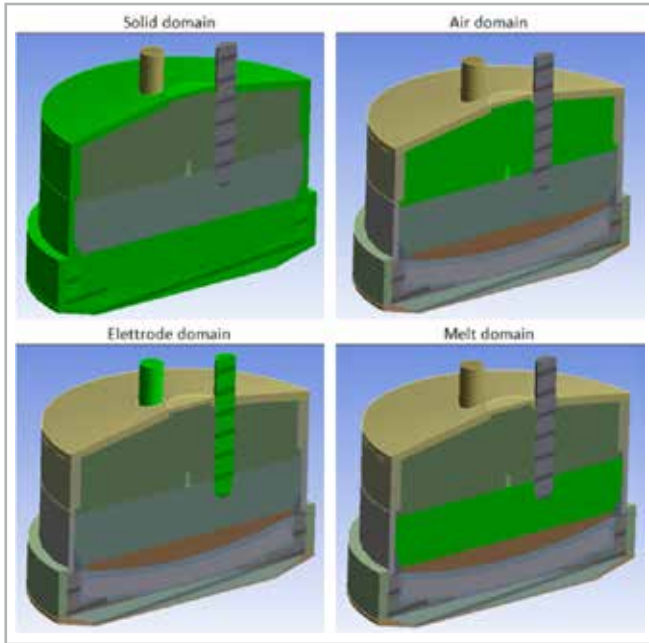

Fig. 3 - Mesh created in ANSYS Workbench

- The electrode diameter
- The electrode depth
- The distance between the electrode axes

The parameters were configured in ANSYS Workbench and a complete tetrahedral mesh of about 3.9M, which is well-suited to a parametric geometry, was created. The mesh was converted into a polymesh (of 0.8M) in ANSYS Fluent. Only one fluid domain, called the melt domain, was used (see Fig. 3). The Air domain was considered as a solid with the thermal properties of air.

A single Fluent case is able to include the electrical physics, the thermal physics and the melt fluid dynamics, if an appropriate configuration, as described in the following paragraph, is used.

Electrical physics configuration

One of the most important properties is the electrical conductivity of the melt. Electrical resistance is a function of:

- the distance between the electrode tips and the iron domain (d)
- the electrical properties of the melt (k_{ele})
- the area through which the current passes (S)

A specific combination of these three parameters defines the electric resistance (R_{ele}) (see Fig. 4a). The Joule effect generated by one electrode is:

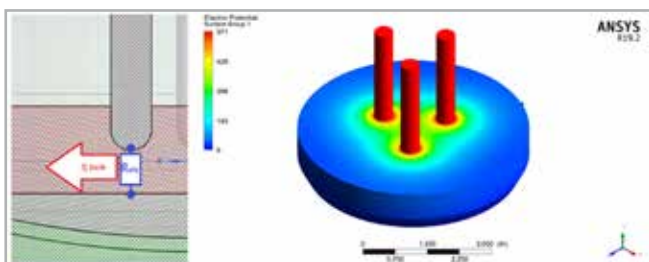

Fig. 4 - L) Electrical resistance between the electrode tips and the iron. R) Field of electrical potential

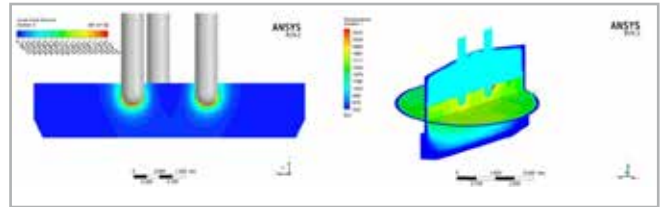

Fig. 5 - Left - Joule heat source. Right - Temperature field

$$P_{ele} = 3P_{joule,electrode} = 3R_{ele}I_{current}^2 \quad R_{ele} = \frac{d}{S}k_{ele}$$

The electrical model considers that the three electrodes are at a steady state and have a constant $I_{current}$ value (their inflow to the melt domain), which is equal for all the electrodes. K_{ele} is constant and temperature and zero voltage are fixed throughout the solid domain (except in the melt and in the air). The resulting electrical potential is shown in Fig. 4b. These hypotheses derive from some preliminary studies, in which different boundary conditions were tested. Once the electrode distance (d) is set, the K_{ele} was corrected via the preliminary studies to obtain the expected P_{ele} . The electrical potential is shown in Fig. 5.

The thermal physics configuration

In this model, only the melt domain is fluid. The air domain is considered solid, with the standard properties of air. However, the contribution of thermal radiation, due to the high temperature of the melt, is important. A Monte Carlo radiation model was chosen, which allows the solid domain to participate in the radiation. The thermal source term, due to the joule effect (Fig. 5a) is concentrated near the electrode tips, inducing the temperature increase in the melt (Fig. 5b). Appropriately convective boundary conditions (heat exchange coefficient and free flow temperature) are imposed on the external surface of the refractory. The roof of the furnace includes a cooling system that reduces the temperature of the air inside the furnace and controls the formation of a crust on the top of the molten rock. This system is modelled using a negative energy source (to extract the estimated thermal power).

The fluid dynamics configuration of the melt

In the real furnace, solid material is added from seven different inlets (Fig. 6a) at different times during the process (controlled by local measurement of the melt temperature). Quantities of the melt are then removed (Fig. 6b) via a single outlet to maintain

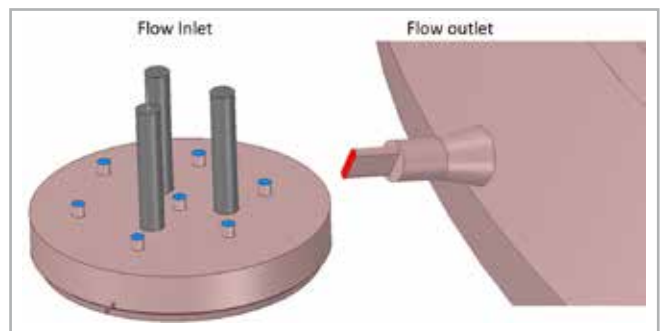

Fig. 6 - Inlet and outlet flow surface

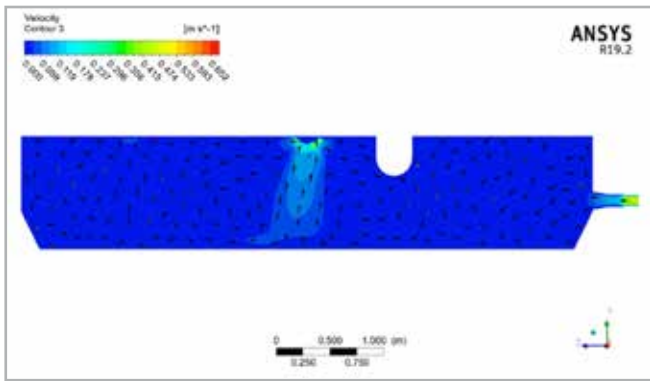

Fig. 7 - The velocity field

a prescribed melt level. A prescribed constant mass flow rate was set in the numerical model in order to use a steady-state simulation. The solidification/melting model in Fluent was used to include the latent heat absorbed by the inflow from these inlets as a result of the phase change from solid to liquid in the melt.

These hypotheses allow the modelling of a continuous flow, and the evaluation of the average velocity field (see Fig. 7) from the inlet to the outlet of the melt domain.

Results

After setting a base case (DP0), three different design points (DP1–DP3) were tested. Fig. 8 shows the distribution of the temperature fields in these four different cases:

- base case (DP0),
- increasing the axle spacing (DP1)
- increasing the depth (DP2)
- decreasing the diameter of the electrodes (DP3)

It is possible to see that a reduction of the distance between the electrode tips and the iron domain induces a reduction of the temperature near the electrodes (due to the lower electrical resistance).

The relative position between the inlet and the electrodes also appears to be important to achieve a homogenous distribution of the temperature inside the melt. Fig. 9 shows the temperature ranges of the melts on the z-x plane. The flow lines from the

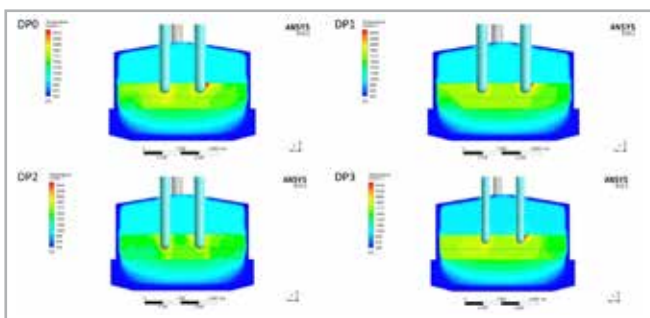

Fig. 8 - Effect on the temperature fields of changing the configuration of the electrodes

inlet, colored according to the intensity of the joule effect, show that the DP1 configuration was able to generate a more uniform temperature in the highlighted area, compared to the DP0.

Conclusion

This paper presents a numerical model for a melting furnace for stone wool. The numerical model was designed using ANSYS FLUENT. The model includes all the main aspects of the real process (the electrical field, the heat transfer process and the fluid dynamics of the melt).

The CFD simulation provided a lot of information about the operating conditions of the electric melter while considering the hypothesis of the dissipation terms. A proper validation on site in the field will enable us to obtain a more reliable setup of the model, to reflect reality as closely as possible.

For more information
 Fabio Villa - EnginSoft
f.villa@enginsoft.com

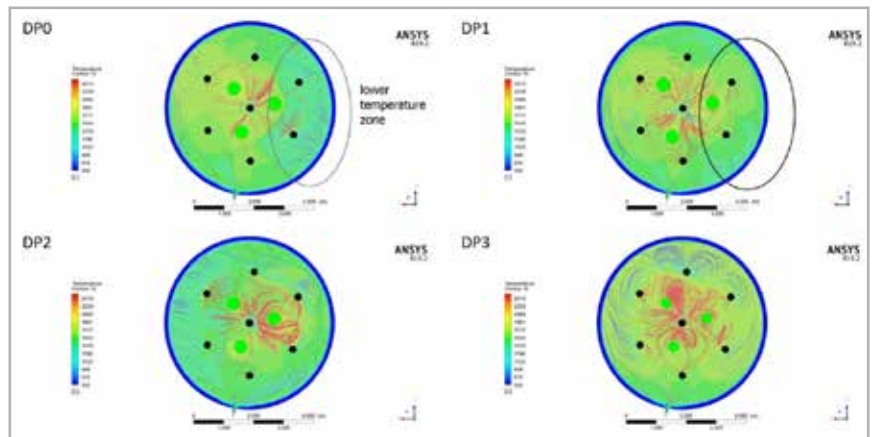

Fig. 9 - The contour of the temperature field of the different design points. Flow lines represent the joule heat source.

About Gamma Meccanica

Gamma Meccanica is one of the world leaders in mineral wool production lines, both of individual machines and of complete lines for the production of mineral wools, namely stone wool and glass wool.

The company also manufactures special lines to produce pipe sections and stitched mattresses, lamellar production lines, ceramic fiber machinery, and stone wool and glass wool hydroponic production lines.

Gamma Meccanica's machinery offers a combination of high performance and advanced technology. It meets and exceeds customer requests by constantly improving quality and energy efficiency, by means of technological evolution and high levels of technical support, in compliance with the strictest environmental standards.

CFD study to optimize the cooling performance of a narrow specialty tractor

Numerical modelling reveals design strengths and weaknesses prior to prototype testing, saving time and money.

By Leonardo Simone Pilò
Argo Tractors



Constant demand for improved engine performance has led to an increase in the heat fluxes through vehicle cooling systems, pushing their design to the limit. In agricultural vehicles, especially in specialty tractors where the hood design is very tight, this cooling problem is compounded: the low vehicle speed, higher operating temperatures and the dirty environment all have a negative impact on cooling performance. In this technical article, a CFD study of various designs for four different specialty tractors: two brands of specialty tractors for vineyard configurations, and two brands of specialty tractors for orchard configurations, are

described. The analysis evaluated the heat flow rate distribution in the hood openings, the flow over the cooling packs and their heat dissipation, as well as the flows and the temperature in the underhood and over the cabin, in order to improve the overall cooling performance and operator comfort and safety.

The study revealed the strengths and weaknesses in the original design as well as in the subsequent modifications, allowing the thermal management to be improved prior to prototype testing, speeding up the design process and saving time and money.

In recent times, vehicle design has become very challenging. Increased environmental considerations, together with the constant demand for improved engine performance, have led to an increase in the heat fluxes through the coolers, pushing the design of the coolant systems to the limit. In agricultural vehicles, and in particular in specialty tractors where the hood design is very tight, this cooling problem is compounded: the low vehicle speed, higher operating temperatures and the dirty environment all have a negative impact on cooling performance.

Solving thermal management problems is essential in the early stages of design. This is where models using computational fluid dynamics (CFD) are increasingly being used to optimize thermal performance prior to production and prototype testing. The subject of this study was a new design for a narrow specialty tractor available in four combinations: a vineyard or orchard configuration under both the Landini and the McCormick brands. The objective of the analysis was to evaluate the flow rate distribution in the hood openings, the flow over the cooling packs and their heat dissipation, as well as the flows and the temperature in the underhood and over the cabin, in order to improve the overall cooling performance and operator comfort and safety.

The automotive literature includes a lot of CFD work on optimizing underhood and front-end cooling modules, but most of these focus on the overall layout or on modifications to individual components. In this study, the entire tractor is examined in order to determine the influence on the cooling performance of both the individual components and their layout under the hood.

Methodology

In this study, a CFD model of the whole tractor was built using the commercial CFD software of the ANSYS 2019R2 suite. In particular, Space Claim Direct Modeler SCDM was used to prepare the geometry from the CAD import, Fluent was used to mesh the model, and CFX to pre-process the model, run the simulation and post-process the results.

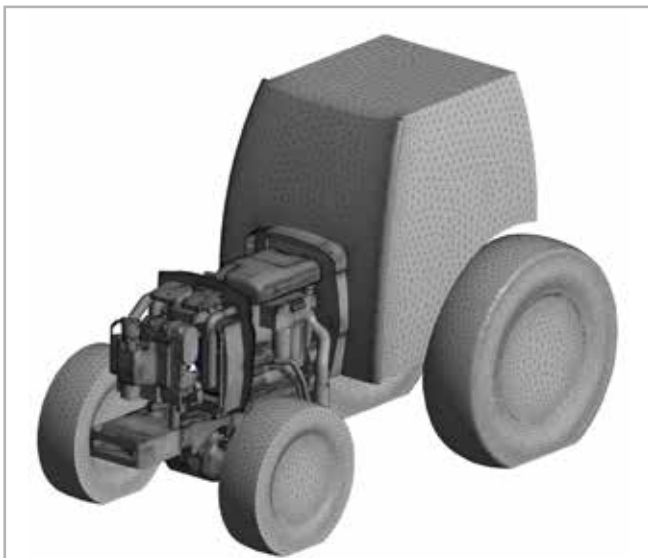

Fig. 1 - The tractor model: the whole tractor was modeled and analyzed.

System Modeling

Due to the complex geometry, some geometric simplification was applied to contain the total number of cells. The components of the under-hood compartment were all included in this study. The tractor cabin, together with the tractor axles and the wheels were also modeled. The tractor was placed inside a virtual wind tunnel box. Two different tetrahedral meshes were constructed: one for the rotating (fan) domain and one for the stationary domain, for a total of about 50 million cells.

The effect of the fan was evaluated by mean of a frozen rotor interface. This enabled the swirling effect of the fan to be considered without complicating the model. The heat exchangers were included in this study as porous media. The viscous and inertial component of the pressure drop was determined by an

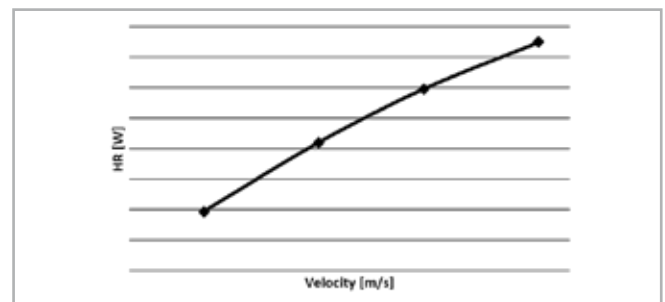

Fig. 2 - Heat Rejection curve: Heat Rejection value against mean velocity data are available for every single radiator

adaptation to the curve of the measured velocity data of the air pressure drop for the heat exchanger of interest. The thermal power exchanged was calculated for each individual radiator by multiplying the value of the Heat Rejection (HR) interpolated to the mean value of the velocity through the heat exchanger by the entering temperature difference (ETD) value calculated at the mean value of Temperature.

$$\text{Thermal Power exchange} = HR_{@ \text{mean velocity}} * \text{ETD}$$

The ETD factor takes into consideration the reduction in the efficiency of the radiator exchange with the increase of the air temperature.

$$\text{ETD} = \frac{T_{\text{max}} - T_{\text{averaged}}}{\text{ETD}_{\text{ref}}}$$

The pressure drop, HR and ETD values have been tabulated and are available from the heat exchanger manufacturers.

The hood inlets are filled with a finely meshed metallic grill. The characteristic length of these metallic grills is smaller than the numerical mesh. The grills were therefore modelled as porous media. To evaluate their pressure drop characteristic, an auxiliary static flow simulation was performed to extract the linear and quadratic coefficients for the pressure losses.

Boundary conditions

The simulation was performed at an air temperature of 40°C. A non-slip boundary condition was applied to the lower face of the domain to represent the road surface. All the other surfaces of the

■ CASE STUDIES

wind tunnel were modeled as opening boundaries to allow the flow to enter or exit freely from the domain. A constant pressure equal to the atmospheric pressure was applied to these faces of the computational domain.

The tractor was assumed to be stationary, the worst condition for cooling performance.

Assumptions

The model was simulated using the following assumptions:

- Steady state, incompressible flow
- Air as Ideal Gas:

$$c_p = 1004.4 \frac{J}{kg \cdot K}, \mu = 1.83 \times 10^{-5} \frac{kg}{ms}, K = 2.061 \times 10^{-2} \frac{W}{mK}$$

- Turbulence was modeled using Menter's shear stress transport (SST) k- ω equations
- Thermal energy exchange was modeled using total energy equilibrium equations
- Thermal radiation from the hot solid body was considered using the P1 radiation model

Simulation and analysis

The conservation equations of mass quantities, momentum, energy, and turbulence for the above model were solved in a multiple CPU cluster until the convergence standards were met. The thermal exchange in the coolant packs was automatically calculated using equations (1) and (2).

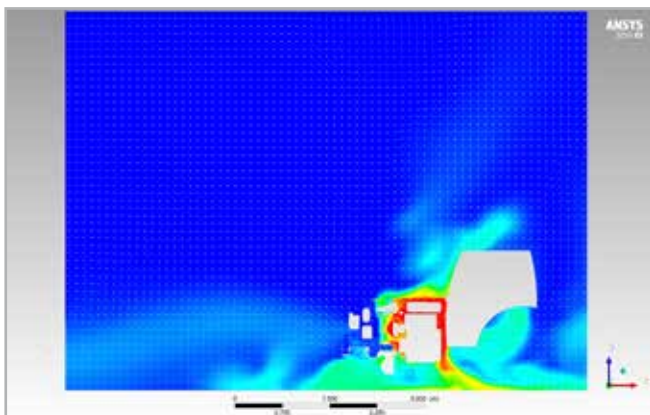

Fig. 3 - Example of results analysis: Temperature contour plot and velocity vectors projected on a longitudinal midplane.

The velocity and temperatures in the regions of interest were then analyzed.

Results

The results of the simulation are explained and analysed below, with particular attention to the area of interest to the vehicle design process.

The main topics are: distribution of mass flow between the hood inlets, distribution of mass flow between the hood outlets, recirculation of flow from the outlets to the inlets, the thermal energy exchanges and temperatures in the coolant packs, and the cabin surface temperature. These results are the most significant in terms of the thermal performance evaluation, providing

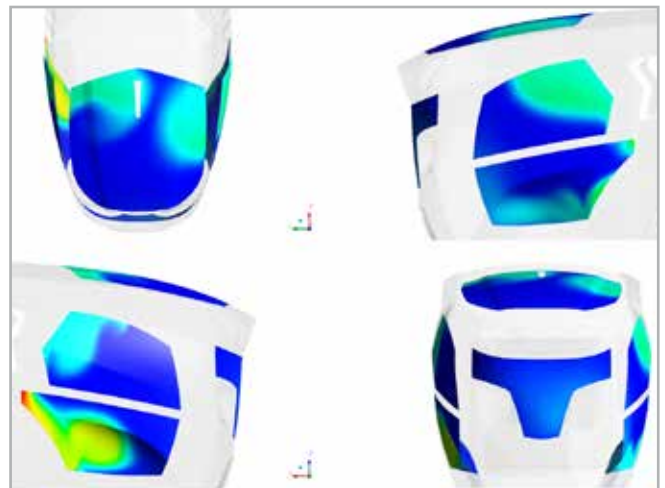

Fig. 4 - Mass flow recirculation: air temperature on the grills is highlighted. Non-blue zones are hotter than room temperature, thus indicating recirculation of hot air from the outlets

direct feedback on potential design modifications to improve performance.

The distribution of mass flow between the hood inlets or outlets, and the flow direction in these openings, provides direct feedback on the design of the openings. These openings should ensure sufficient airflow through the coolant packs to meet the objective of thermal energy exchange in the coolant packs.

The air temperature at the grills was also evaluated. The areas of the grill that are warmer than the ambient temperature indicate the recirculation of the hot air flow from the outlets. In order to maximize the performance of heat management, these areas should be kept to a minimum.

Not least, the cabin surface temperature was analysed. Hot areas here should be minimized to improve operator comfort in the cabin, which can be achieved by redirecting the hot flow from the outlets away from cabin.

The first preliminary design of the tractor hood showed several problems that could be improved. The first simulation highlighted the strengths and weaknesses of the hood design; with this in mind, four additional designs were subsequently simulated to improve the thermal management.

	Bottom Opening L	Top Opening	Bottom Opening R
2nd version	Open	Open	Open
Option 2.1	Closed	Closed	Closed
Option 2.2	Open	Closed	Closed
Option 2.3	Open	Open	Closed

Fig. 5 - Design modification: combination tested

Design modifications

The first modification of the layout introduced:

- Wider, more angulated hood outlets
- Slotted openings in the lower part
- A rectangular opening at the top

This design (“second version”, below), as we will see later, aggravated the problem of recirculation, so the new upper and lower openings were selectively closed, as shown in the table below.

About Argo Tractors

Argo Tractors designs, produces and distributes a wide range of tractors under three historical brand names: Landini, McCormick and Valpadana. It is a global company with around 1800 employees that makes continuous investments in R&D, of which this work is just one result.

	Avg. Temperature@ Grills	Power @ Radiator	MFR @ Left Exits	MFR @ Right Exits	MFR @ Left Opening	MFR @ Top Opening	MFR @ Right Opening	Total MFR @ Exits
1st Design (reference)	REF	REF	52%	48%	-	-	-	100%
2nd Design	11,74%	-5,02%	84%	76%	28%	20%	20%	228%
Option 2.1	2,26%	3,49%	112%	88%	-	-	-	200%
Option 2.2	-0,90%	3,77%	100%	76%	28%	-	-	204%
Option 2.3	-4,74%	7,95%	80%	76%	28%	20%	-	204%

These new layouts were modelled and simulated as mentioned previously. The results were then analysed and discussed, following the methodology of the first design. The results are summarized in the following table.

The second version, as expected, shows a significant increase in the mass flow evacuated from the outlets (all values are percentages of the total mass flow rate from the outlets of the first design). This improvement in flow evacuation, however, had no impact on the thermal power exchanged in the water radiator; the power actually worsened by 5%.

In order to evaluate the best trade-off between flow ejection and recirculation reduction, the three options mentioned above were analysed.

An improvement in the average grill temperature shows a good correlation with the thermal power exchange performance, being the most important factor in thermal management. Option 2.3 was therefore confirmed as the best hood design.

A close correlation between the average grill temperature (and thus the flow recirculation) and the thermal performance of the coolers is an important proof of this study. Similarly, other synthetic values can be discovered to describe the overall suitability of each design and address further performance improvements.

Conclusions

CFD simulation is an important tool for evaluating and optimizing the preliminary designs of a tractor hood to improve the performance of thermal management. In this study, the CFD analysis revealed strengths and weaknesses in the design and was used to analyze the subsequent modifications.

These modifications enabled the thermal management to be improved prior to prototype testing, speeding up the design process and saving time and money. In addition, the analysis highlighted the most impactful parameters with respect to thermal performance, assisting with future layout decisions.

As a further step, this study will be validated against real case tests as soon as the first tractor prototype is produced.

Acknowledgements

The author would like to thank the ArgoTractors’ Engineering Department for their support and permission to publish this paper. The valuable contribution and collaboration of the engineer Diana Magnabosco from EnginSoft is also gratefully acknowledged.

For more information
 Diana Magnabosco - EnginSoft
d.magnabosco@enginsoft.com

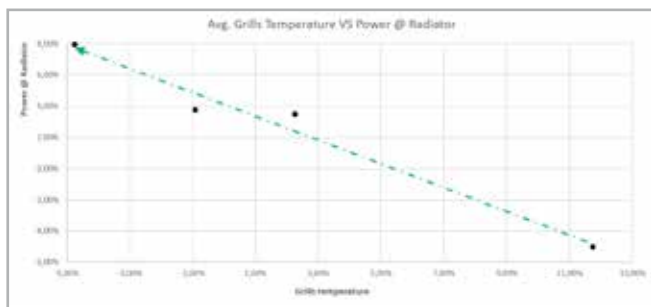

Fig. 6 - Average grill temperature vs. energy exchanged in the radiator: dotted black line shows the linear interpolation and correlation value

A method to conduct dynamic analyses of floating solar structures using AQWA

Structural analysis method also considers response characteristics over time

By Jeongpil Hwang and Eunsil Han
taesung S&E

This technical paper presents an analysis process to accurately examine the environmental loads and structural stability of a Floating photovoltaic (PV) power plant. The method includes a hydrodynamic analysis of the Floating PV in its water-based environment as well as a structural analysis of its structural stability based on the characteristics of motion it undergoes. The method proposed used ANSYS AQWA which allows environmental conditions to be included in the analysis such as the fender, the joint, the cable winch, irregular waves, birds, etc.

A new design solution for photovoltaic (PV) power plants is the use of Floating PV systems (FPVS), which are generally installed on bodies of water such as natural lakes, dams, reservoirs, or the ocean. This market is expected to expand because floating PV systems cause less environmental pollution problems than the traditional approach to the development of solar power. This paper introduces a method to conduct the hydrodynamic analysis of floating PV structures using ANSYS AQWA as well as a structural analysis of floating PV structures that considers the response characteristics over time.

The analysis process

The installed floating photovoltaic module structure is exposed to severe environmental loads such as winds and waves. Therefore, the FPVS engineers needed to establish an analytical process for conducting a structural evaluation of the robustness of the solar structure and the solar modules. To this end, our team proposes a four-step process of numerical analysis of the FPVS to understand the hydrodynamics and structural characteristics of floating solar structures, consisting of:

1. CAD modeling using ANSYS SpaceClaim
2. Computational fluid dynamics (CFD) analysis of wind load using ANSYS AIM or ANSYS Fluent
3. Hydrodynamic analysis of wave and wind speed using ANSYS AQWA
4. Time response analysis of the overall structures using ANSYS Mechanical

To summarize, firstly we used ANSYS CFD AIM for fluid dynamics analysis on the extraction of load data. Then, we used ANSYS AQWA for hydrodynamic analysis of the aquatic conditions and environmental loads. Lastly, we used ANSYS Mechanical for the structural analysis of the Floating PV structure, including the frames and solar panels.

Model description (TSNE's Arbitrary Model)

We used three types of models for the different analyses (Fig.1)

Types	CFD Model	AQWA Model	Mechanical Model
CAD Model			
Analysis	Fluid Dynamic Analysis	Hydrodynamic Analysis	Structural Analysis

Fig. 1 - Three types of models

Hydrodynamic analysis using ANSYS AQWA

Since the use of AQWA in this analysis process is different from the general analysis method, we have explained it in more detail. The fluid dynamic analysis to derive the loads on the panels of the floating solar structure was conducted with ANSYS CFD AIM, and the hydrodynamic analysis of the water conditions and the environmental loads was conducted with ANSYS AQWA. It is important to emphasize

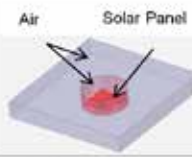
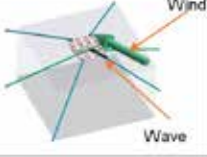
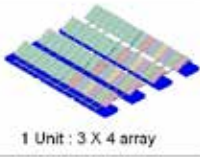
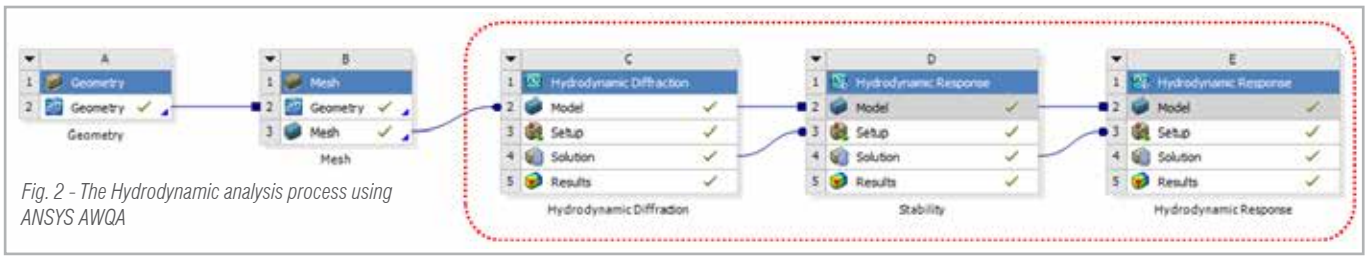

Fig. 2 - The Hydrodynamic analysis process using ANSYS AQWA

the use of ANSYS AQWA in our analysis process. Firstly, we ran a Hydrodynamic Diffraction analysis of the floating body to check its stability. Secondly, we obtained the specific behaviors of the floating body itself using hydrodynamic response analysis. Then, we conducted a simulation that considered the environmental loads created by the wind and waves to obtain the data of the structural position of the floating body. (Please see the red-dotted box in Fig. 2)

Results

Fig. 3 shows the results of the CFD analysis in terms of the total speed and pressure of wind from the direction of 90 degrees and from 180 degrees.

We extracted each X, Y, Z Force component according to the wind direction from -180 degrees to 180 degrees of total wind force

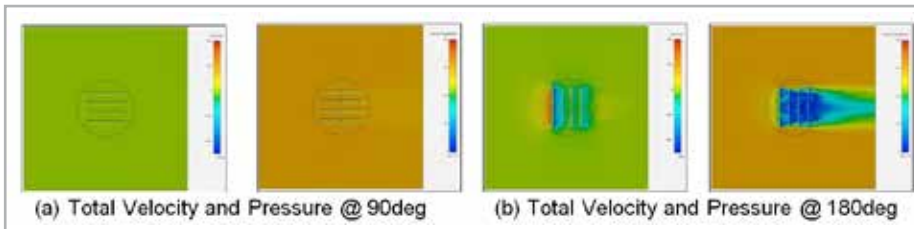

Fig. 3 - Total Velocity and Pressure with wind directions of 90 and 180 degrees

Angle	Force, X(N)	Force, Y(N)	Force, Z(N)
-180	10630.88886	3.782211957	17998.32397
-170	12418.10102	-2160.599692	21313.05518
-160	14790.7097	-5204.886725	26491.83062
-150	14874.63493	-8447.234269	29165.94937
-140	13457.93799	-11005.15894	29756.527

Total Wind Force

Angle	X(Coef)	Y(Coef)	Z(Coef)
-180	11.81209873	0.006425763	19.99813775
-170	13.79789005	-2.400599658	23.88117242
-160	16.43412188	-5.782763025	29.43584513
-150	16.63848326	-9.885815855	32.40661041
-140	14.95326443	-12.22795438	33.06280778

Wind Force Coefficient

Fig. 4 - Wind force and wind coefficient by wind direction

with CFD analysis using parametric variables, as shown in Fig. 4.

We transferred these wind force data to wind load coefficients by dividing by the square of the velocity. This wind load coefficient condition applies to the hydrodynamic analysis of floating structures.

Fig. 5 shows the wave surface elevation over time using the hydrodynamic diffraction with the above-mentioned wind coefficient results. This result shows the wave properties such as diffraction and radiation around the floating structure according to the wave

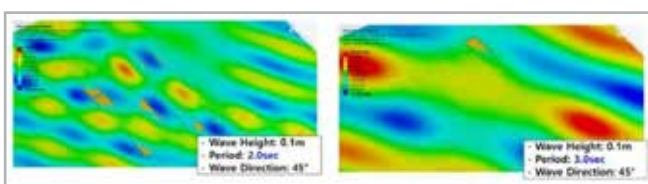

Fig.5 - The wave surface elevation

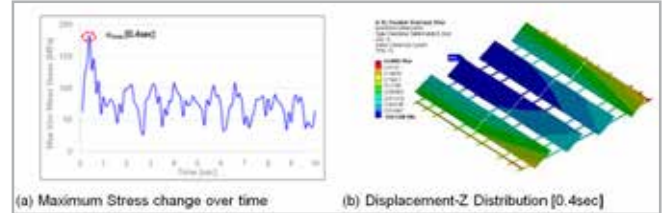

Fig.6 - Transient structural analysis

conditions such as wave direction and wave height. The highest wave height was found to be 0.26m at the 0.2sec period.

Finally, Fig. 6 shows the results of the transient structural analysis. These represent the maximum stress on the structure over time with the solar sample model installed in the water-based environment.

The analysis revealed that the sample model experienced its most unstable structural state at 0.4 sec and a maximum stress of 184 MPa.

Conclusions

Since no analysis process exists for the structural evaluation of a Floating PV installation, it was necessary to establish an analysis process to accurately examine the environmental loads and structural stability of a Floating PV. With this purpose in mind, this paper presents a method of conducting a hydrodynamic analysis of a Floating PV in its water-based environment and a structural analysis for examining its structural stability according to the characteristics of motion it undergoes. ANSYS AQWA enables various problems to be included in the analysis such as multiple environmental conditions including the fender, the joint, the cable winch, irregular waves, birds, etc. Furthermore, a fatigue analysis can be conducted to evaluate the fatigue life of the Floating PV.

References

- [1] "ANSYS AQWA Reference Manual Release 2019 R2", 2019
- [2] "ANSYS AIM Manual Documentation 2019 R2", 2019
- [3] Yeom Duckjun, Dynamics of Marine Structure, UUP, 2010

For more information
jphwang@tsne.com or ehan@tsne.co.kr
 or visit: www.tsne.com



IVECO S-WAY truck: perfecting cab design to maximize driving comfort

Employing ESTECO optimization-driven design approach to reduce truck cab vibration.

IVECO relies on ESTECO technology to innovate its simulation-driven product development process. IVECO engineers combine the use of CAD and CAE solvers within modeFRONTIER workflow to automatically execute parametric simulations across a wide spectrum of disciplines: structural calculation (crash, durability, strength), fluid dynamics, NVH (Noise, Vibration, Harshness) and vehicle dynamics. On top of the automated simulation process, they apply optimization algorithms to achieve better vehicle designs with increased performance at reduced production costs.

“The optimization process led us to achieve up to 10% reduction in cab vibration.”

CHALLENGE

The IVECO S-WAY is a complete transport solution which provides excellent life on board conditions to drivers.

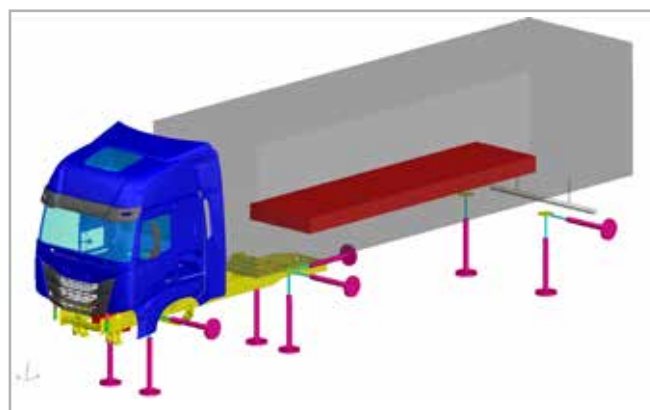

3D truck model generated in MSC Adams/Car

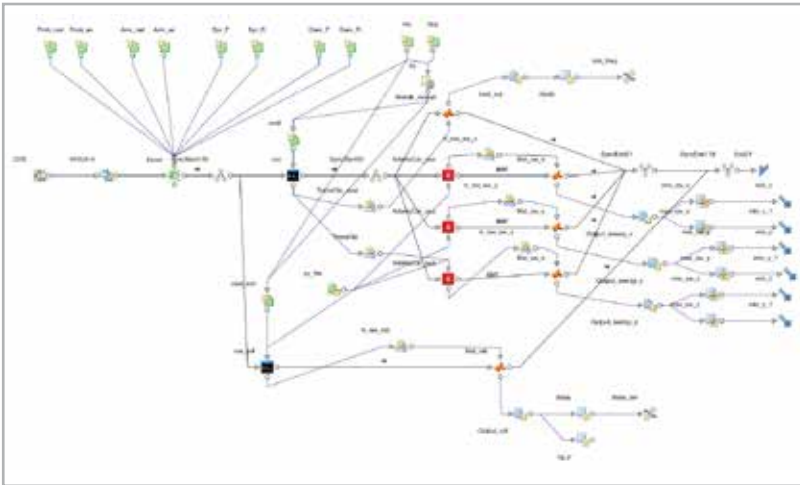

modeFRONTIER workflow automatically tunes the suspension properties to optimize vibration, cab movements and comfort

About Iveco

As a major player in the global transport world, Iveco is an international leader in the development, manufacture, marketing and servicing of a vast range of light, medium and heavy commercial vehicles. It also manufactures passenger transport vehicles and special vehicles for defence, civil protection and specific missions like fire-fighting. The vehicles adopt the latest engineering technologies, applied to a comprehensive range of engines running on diesel and alternative fuels.

iveco.com

With a brand-new cab designed to enhance aerodynamic performance and increase fuel efficiency, engineers at IVECO had to completely rethink the suspension system to improve the comfort standard level. In fact, one of the main challenges of the project was to evaluate the cab comfort before the construction of any prototype. Consequently, they made use of multi-body simulation and optimization techniques to verify the overall behavior of the cab by defining the correct set of stiffness and damping parameters for the suspension elastic components.

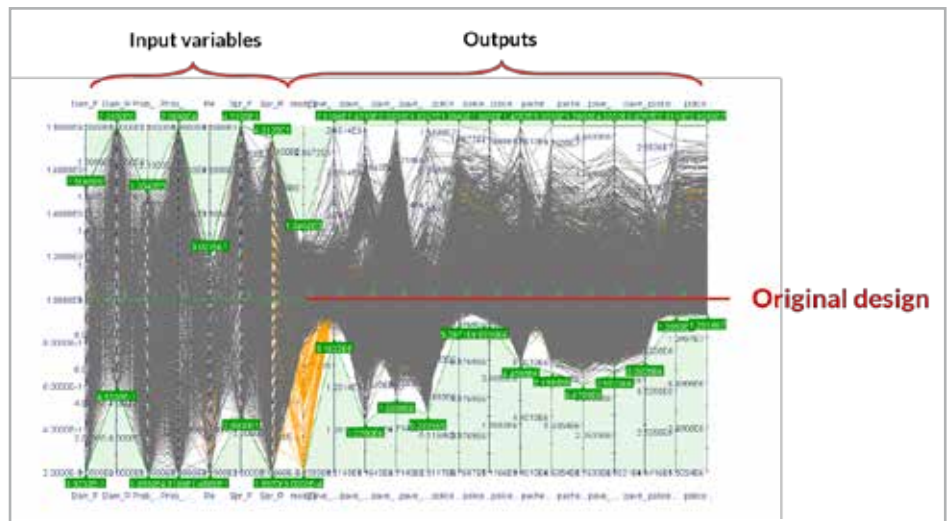

Parallel Coordinate Chart shows up to 10% reduction in cab vibration

SOLUTION

A 3D truck model was generated in MSC Adams/Car to simulate the behavior of mechanical components (cab body, suspension, actuator, tractor and trailer frame) on different proving grounds as pave, patched asphalt and speed bump. The simulation model was directly integrated in modeFRONTIER workflow to automatically tune the suspension properties, with the aim of optimizing output parameters related to vibration, cab movements and comfort. An initial Design of Experiments (DOE) analysis allowed to identify the correlation between design variables and system responses, with the aim of simplifying the multi-body simulation model to be further validated in the optimization process. Finally, the MOGA-II algorithm, available in modeFRONTIER, enabled engineers to pick the right designs with minimized cab vibration on different paths.

BENEFITS

“We took advantage of modeFRONTIER software solution to automatically execute a huge number of simulations and evaluate thousands suspension system designs within few weeks. The Parallel Coordinate Chart enabled us to easily plot several variables and visualize the distribution of the designs in an effective manner. The optimization process led us to achieve

up to 10% reduction in cab vibration compared to the baseline. Moreover, the results achieved with modeFRONTIER allowed us to identify specific properties of dampers, springs and bushes that have been considered during the prototype phase of the IVECO S-WAY truck development” said Andrea Morello, Performance Engineer and CAE Senior Analyst, IVECO - CNH Industrial.

About Esteco

ESTECO is an independent software provider, highly specialized in numerical optimization and simulation data management with a sound scientific foundation and a flexible approach to customer needs. With 20 years' experience, the company supports leading organizations in designing the products of the future, today. esteco.com

For more information
 Francesco Franchini - EnginSoft
f.franchini@enginsoft.com



Comparing the performance and results of different FEM solvers



A study by Industrie Saleri Italo to automate its simulation flow chart

By Mirko Gozio
Industrie Saleri Italo

In this technical article, Industrie Saleri Italo describes how it analyzed and compared the performance and results the different finite element method (FEM) solvers it uses, namely ANSYS Mechanical, Code Aster and Epilysis, using cases that are very common in the literature, as well as some industrial applications to compare the linear and non-linear analysis results, with the intention of investigating the potential of the open source FEM solver, Code Aster. A further objective of the study was to define a common methodology for pre- and post-processing in order to automate the company's simulation flowchart as much as possible.

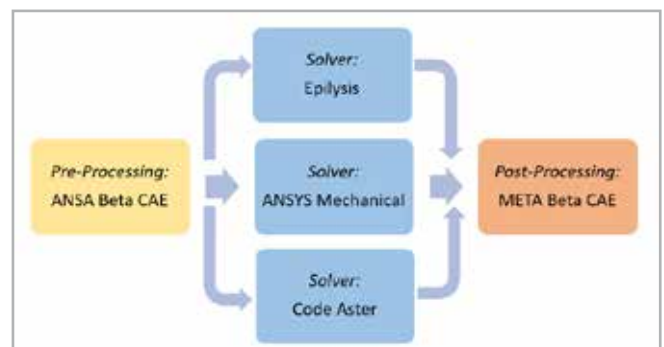

Fig. 1 - Current simulation flow chart at Industrie Saleri

The purpose of this study was to analyze and compare the performance and the results of the different finite element method (FEM) solvers available at Industrie Saleri Italo, namely ANSYS Mechanical, Code Aster and Epilysis. ANSYS Mechanical is one of the most well-known commercial FEM solvers, Epilysis is a new commercial FEM solver provided by ANSA Beta CAE, and Code Aster is one of the most famous open source FEM solvers developed by EDF. The cases used for the analysis are very common in the literature, and industrial applications were

also evaluated in order to compare the results of linear and non-linear analysis. Our intention was to investigate the potential of the open source FEM solver Code Aster compared to the other two commercial solvers available in our company. Another objective of the study was to define a common methodology for pre- and post-processing, independent of the solver chosen, using Beta CAE products, in order to automate the simulation flowchart as much as possible.

At the moment, the simulation flow chart at Industrie Saleri is composed of three steps (Fig. 1):

- Pre-processing using ANSA Beta CAE
- FEM Solver using ANSYS Mechanical
- Post-processing using META Beta CAE

Currently, ANSA Beta CAE is not able to generate a mesh compatible with Code Aster, so the meshes used in Code Aster cases are generated using Salome. Similar meshes were generated in ANSA and Salome for a reliable comparison of the results. The cases analyzed in this study are two common examples from the literature: a fixed beam subject to a bending load, and a plate with a hole subject to an axial load.

Fixed Beam

This case analyzed the displacements generated by a bending load on a beam with a rectangular cross-section (Fig. 2).

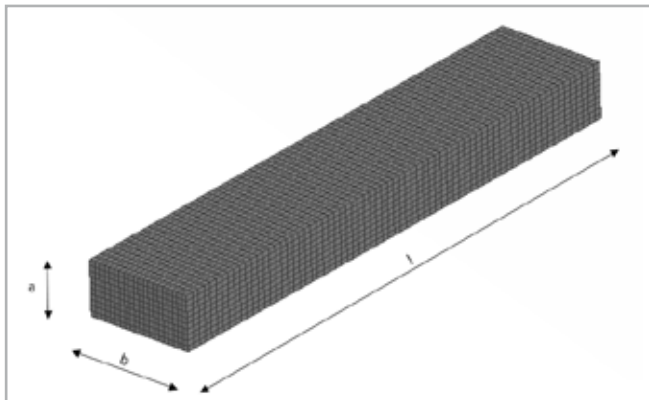

Fig. 2 - Rectangular cross-section beam

Table 1 details the characteristics of the beam and of the bending load.

E [MPa]	a [mm]	b [mm]	L [mm]	P [N]	J [mm ⁴]
210000	20	40	200	2000	26666,67

Table 1 - Characteristics of the beam

The results of the FEM solvers were compared to the analytical results obtained using the deflection curve method (eqn.2) in order to verify the reliability of the numerical calculations.

$$\frac{d^2v}{dx^2} = -\frac{M(x)}{EJ} \quad \text{(eqn. 1)}$$

$$v(x) = -\frac{P}{EJ} \left(\frac{x^3}{6} - \frac{Lx^2}{2} \right) \quad \text{(eqn. 2)}$$

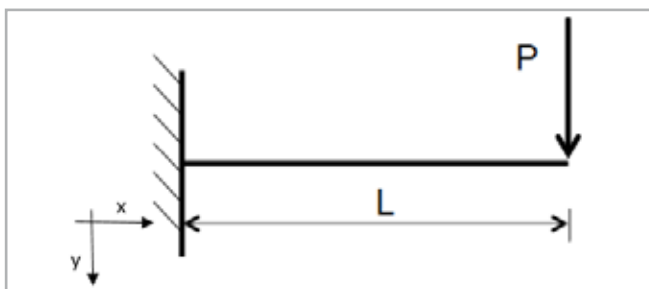

Fig. 3: Deflection curve method

The data of the mesh used in the different FEM solvers are shown in Table 2.

MESH --> first order hexa-elements			
	Code Aster	ANSYS	Epilysis
N° of elements	14000	14000	14000
Dimension of section elements [mm]	2	2	2
N° of elements along the length	70	70	70
Software	Salome	ANSA	ANSA

Table 2 - Data of the mesh

Fig. 4 shows the quantitative comparison of the results obtained using the three FEM solvers.

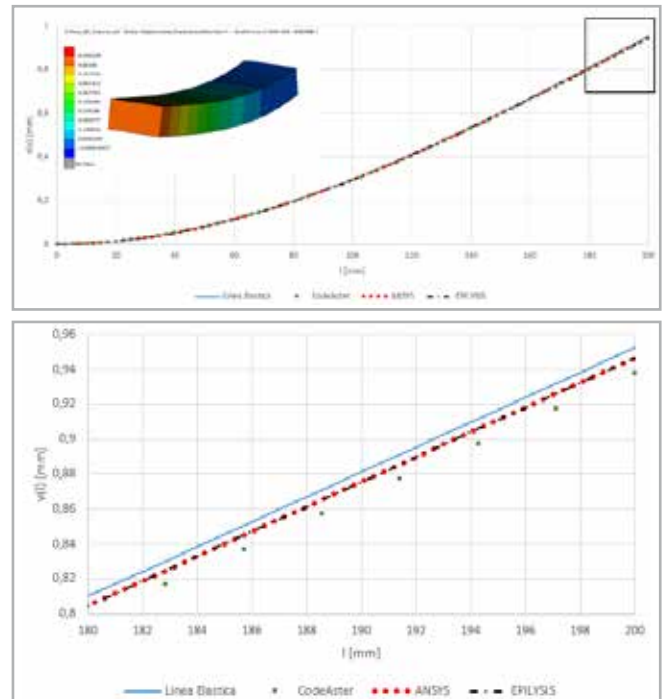

Fig. 4 - Comparison of the results

We plotted the percentage errors of the results in a graph (see Fig. 5) to evaluate the accuracy of the results obtained with the FEM solvers compared to the analytical solution.

Far from the constraint, the maximum percentage of error is -1.61% for Code Aster, -0.645% for ANSYS and -0.646% for Epilysis.

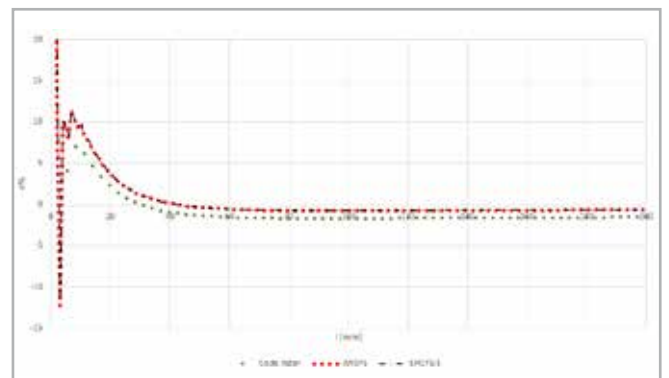

Fig. 5 - Percentage errors of the results

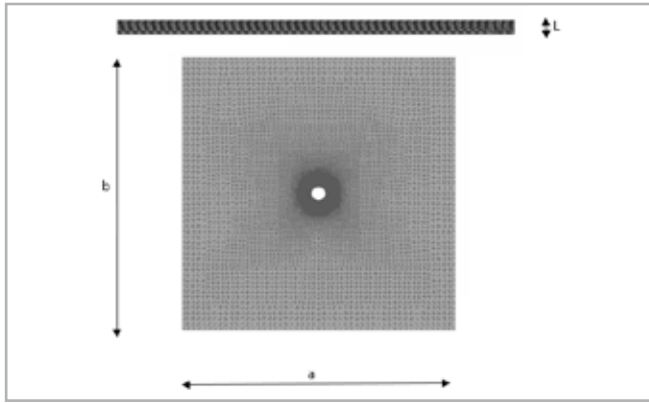

Fig. 6 - FEM model of the plate

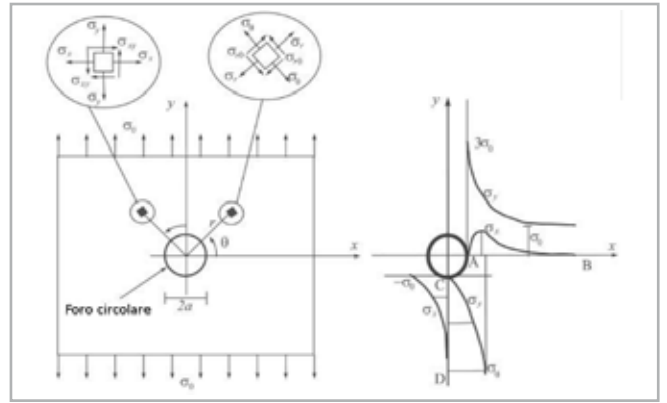

Fig. 7 - Analytical solution of the plate

Plate with a hole

In the second case, the Von Mises stresses generated by an axial load on a plate with a hole (Fig. 6) were analyzed. The aim of this study was to verify the reliability of the numerical calculation on the area near the hole, where there are high stresses generated by the notch effect ($\sigma_{max} = k_t \sigma_n$). We obtained the notch effect for this type of problem from the literature and it is $k_t = 3$. The characteristics and the data of the plate are provided in Table 3.

E [MPa]	a [mm]	b [mm]	L [mm]	F [N]	Hole diameter [mm]
210000	400	400	10	100000	20

Table 3 - Characteristics and data of the plate

The mesh of the area near the hole is very fine in order to try to generate a high reliability of the Von Mises stresses on the area affected by the notch effect.

Unfortunately, in this case, the comparison between the results of Code Aster with the results of ANSYS Mechanical and Epilysis were influenced by the fact that it was impossible to replicate the mesh generated by ANSA to Salome, so a similar mesh size was used (especially on the area close to the hole) to achieve a comparable number of elements (see Table 4).

MESH->second order tetra-elements			
	Code Aster	ANSYS	Epilysis
n° of elements	318554	390373	390373
Software	Salome	ANSA	ANSA

Table 4 - Data of the mesh

$$\text{stress along x axis: } \begin{cases} \sigma_r = \frac{\sigma}{2} \left(1 - \frac{a^2}{r^2}\right) - \frac{\sigma}{2} \left(1 + \frac{3a^4}{r^4} - \frac{4a^2}{r^2}\right) \\ \sigma_\theta = \frac{\sigma}{2} \left(1 - \frac{a^2}{r^2}\right) + \frac{\sigma}{2} \left(1 + \frac{3a^4}{r^4}\right) \\ \tau_{r\theta} = 0 \end{cases} \quad (\text{eqn. 3})$$

$$\text{stress along y axis: } \begin{cases} \sigma_r = \frac{\sigma}{2} \left(1 - \frac{a^2}{r^2}\right) + \frac{\sigma}{2} \left(1 + \frac{3a^4}{r^4} - \frac{4a^2}{r^2}\right) \\ \sigma_\theta = \frac{\sigma}{2} \left(1 - \frac{a^2}{r^2}\right) - \frac{\sigma}{2} \left(1 + \frac{3a^4}{r^4}\right) \\ \tau_{r\theta} = 0 \end{cases} \quad (\text{eqn. 4})$$

The FEM results were compared with the analytical solution. From the literature it was possible to calculate the two principal stresses σ_r and σ_θ (eqn. 3, 4), assuming that the third principal stress along the perpendicular direction of the plate plane is equal to $\sigma_z = 0$ MPa.

Where σ is the axial stress on the plate equal to $\sigma = F/A$ (F is the axial load and A the section of the plate) and r is the distance from the centre of the hole.

The results evaluated are the Von Mises stresses along the path perpendicular to the direction of the axial load (+ x-axis) and along the path parallel to the direction of the axial load (+ y-direction). The analytical Von Mises stresses are calculated using eqn. 5.

$$\sigma_{VM} = \sqrt{\sigma_r^2 + \sigma_\theta^2 - \sigma_r \sigma_\theta} \quad (\text{eqn. 5})$$

Fig. 8 shows the results obtained using ANSYS Mechanical for qualitative purposes, whereas in Fig. 9 the Von Mises stresses obtained by the different FEM solvers are plotted with the analytical solution in order to create a quantitative comparison. The Von Mises stresses were evaluated at the center of the plate thickness. Looking at the graphs, the discrepancy between the results is evident, especially in the area near the hole.

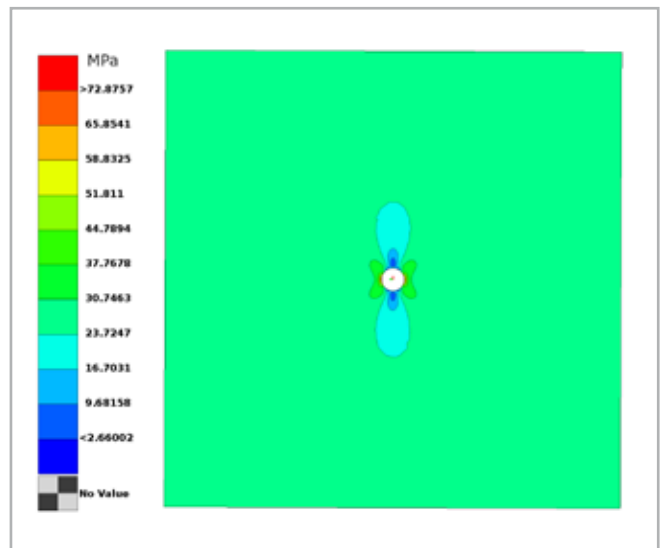

Fig. 8 - ANSYS Mechanical results

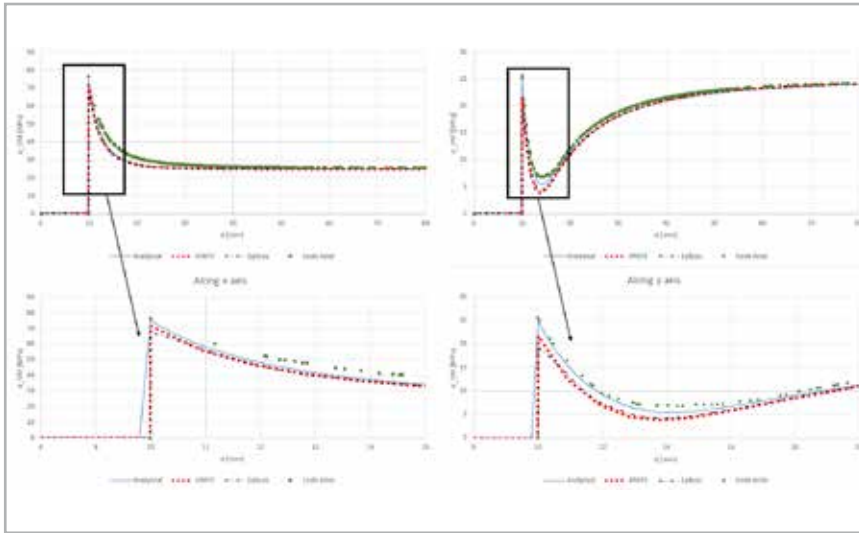

Fig. 9 - Comparison of the Von Mises stresses along x and y axis

The percentage errors of the results are plotted in the graph in Fig. 10 in order to evaluate the accuracy of the results of the FEM solvers with respect to the analytical solution.

Looking at the graphs it is evident that the results of Code Aster are the least accurate and tend to oversize the Von Mises stresses. However, it should be remembered that the Code Aster results depend on the mesh generated by Salome, which is similar but not equal to the mesh generated by ANSA, which leads to the assumption that the grid could be improved. It would be interesting to repeat the analysis once ANSA can generate a compatible mesh for Code Aster.

Conclusion

Looking at the results of the analysis, it is clear that Code Aster has great potential to be included in our simulation flow chart. It is important to consider that the discrepancy of the results in the second test case were dependent on the mesh, so it would be interesting to compare the results again once ANSA can generate a compatible mesh for Code Aster.

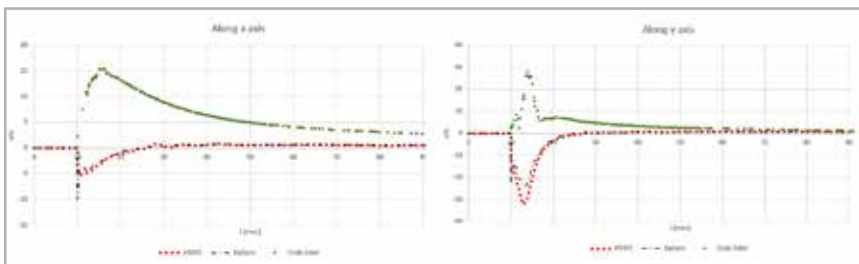

Fig. 10 - Percentage errors

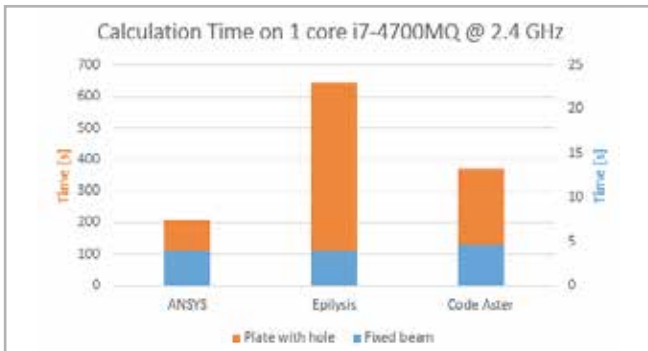
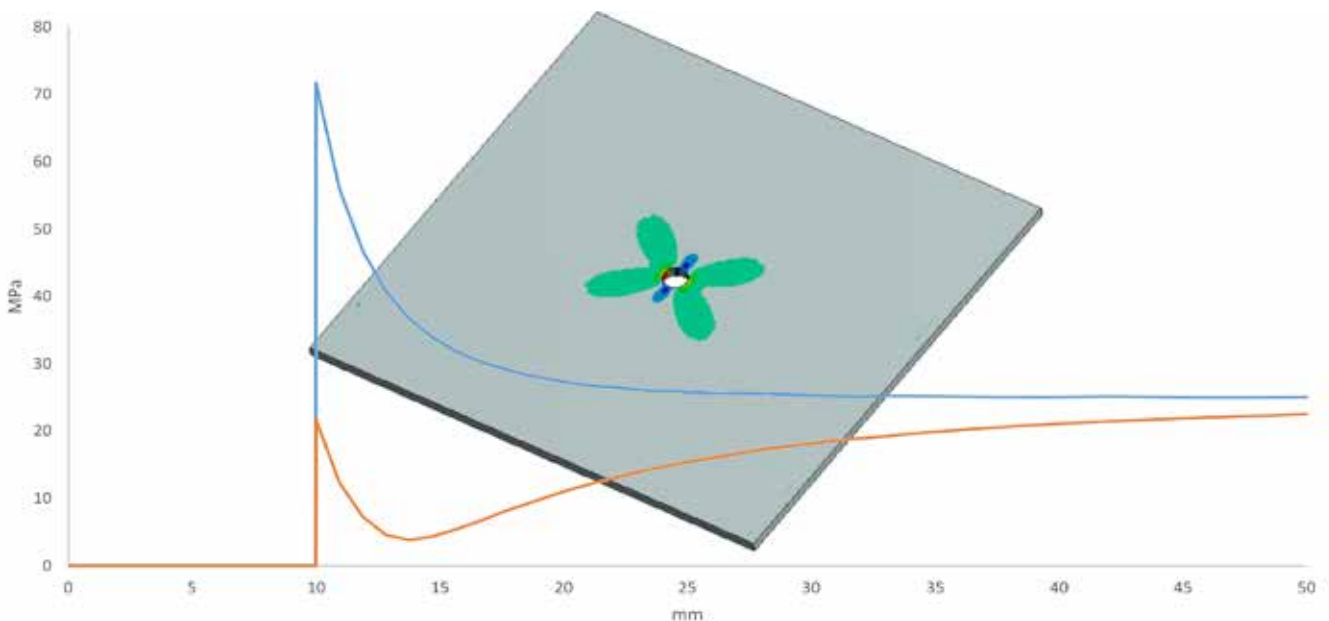

Fig.11 - Calculation time comparison

Finally, it was also interesting to compare the calculation time of the three solvers, shown in Fig. 11. It is noteworthy that the open source Code Aster is located between the two other commercial solvers.

For more information
 Mirko Gozio - Industrie Saleri
mirko.gozio@saleri.it





By Andrea Rapisarda, Francesco Faginoli and Raffaele Galassi
Faber

The impact of numerical analysis on the efficiency of cooker hood ventilation systems

Minimizes trial and error activities and costs and improves right-first-time results.

Kitchen appliances today are also designed with the objective of reducing their environmental impact. Particularly, the design of cooker hood ventilation systems considers how to reduce their energy consumption and polluting emissions. The improvement of the fluid-dynamic efficiency of the ventilation system is one of the main areas under examination. This technical article describes how CFD analysis minimizes trial and error activities and costs and improves RFT – “right first time” – results.

The design of the latest kitchen appliances is strongly influenced by the important objective of reducing environmental impact. Extensive studies are under way on cooker hood ventilation systems with the purpose of improving their efficiency in reducing

both energy consumption and polluting emissions. In addition, the European Commission, with the new regulations and energy labels on products, is encouraging companies to optimize cooker hoods by using new technologies. The improvement of the fluid-dynamic efficiency of the ventilation system is one of the main areas to which many efforts are being devoted.

The primary purpose of an extractor hood is to ventilate a kitchen, removing the odors, steam, smoke, and heat that result from cooking; this is possible due to the internal ventilation system. The main part of the ventilation system, known as the centrifugal fan unit, is an impeller driven by an electric motor located inside a fan. The new European Directives have introduced a new type of Energy Label and a parameter for Fluid Dynamic Efficiency (FDE)

that obliges companies to improve their methods of producing items. Computational fluid dynamic methods are a valuable tool for studying these complex phenomenon with a high degree of accuracy.

The first part of this study concerns the implementation and validation of a numerical model using our experimental data. The characteristic experimental curve is presented and compared with the different numerical results obtained. Then, the redesign of different geometric parameters was performed to optimize the flow field within the ventilation system and its FDE value. The best result obtained was then used to perform experimental tests in order to confirm the numerical data. In the final part, thermal and structural analyses were carried out to predict the behavior under operating and transport conditions.

The CFD numerical model

ANSYS CFX 19, commercial computational fluid dynamics (CFD) software, was used to develop a numerical model of the centrifugal fan unit. The computational domain was comprised of the fan geometry and the impeller (realized using the Blade Modeler) (see Fig. 1).

Experimental tests were conducted to generate all the numerical data needed for the numerical validation. The necessary data related to the electric engine were collected with an experimental test and included: torque, efficiency and consumption related to the rotations per minute (RPM). The necessary data related to the mass flow rate was collected by plotting the Pressure-Volumetric Flow Rate curve on a graph. This was obtained with an experimental test using the current form of the centrifugal fan unit. The validation was performed at four different operating points.

Fig. 2 compares the numerical results with the experimental data. The maximum relative percentage error obtained in the Best Efficiency Point (BEP) was around 5% and the averaged value was around 2%.

Optimization of the CFD model

The result obtained around the maximum FDE point was used to verify the flow trend inside the fan unit and consequently to modify the shapes and geometries to minimize the recirculation and backflow zones. FDE depends on the volumetric air flow (QBEP), backpressure level (PBEP) and energy consumption of the motor (WBEP), as shown in the equation below:

$$FDE_{\text{total}} = \frac{Q_{BEP} \times P_{BEP}}{3\,600 \times W_{BEP}} \times 100$$

The following analyses were conducted for the same engine performance in order to maintain the same product cost. It was therefore important to monitor the engine torque (which influences the consumption) for all impeller designs. Considering the above equation, it was necessary to improve the mass flow rate or the backpressure of the centrifugal fan unit.

In the first part of the optimization, the fan of the present centrifugal fan unit underwent minimal changes to the inlet area and the grid located in the inlet areas to ensure safety. In the second part, the geometric parameters of the impeller were modified. The correct way to obtain higher performance is to operate the electric motor close to the point of maximum efficiency. To achieve this, a dozen or so configurations were tested by changing the number, angle and pitch of the blades. In some configurations, the numerical results showed that even if smoother flow fields were obtained, the FDE was not improved due to the decrease in backpressure. For this reason, a trade-off was chosen between the smooth flow field, the pressure increase and the torque value.

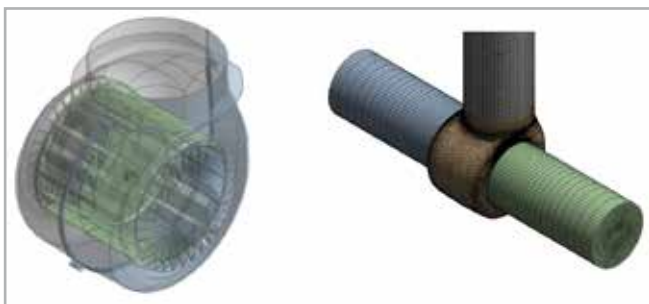

Fig. 1 - Computational domain and boundary conditions

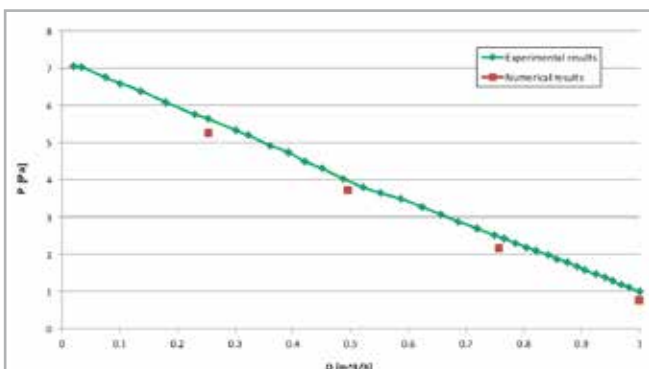

Fig. 2 - Experimental P-Q curve compared to the CFD results

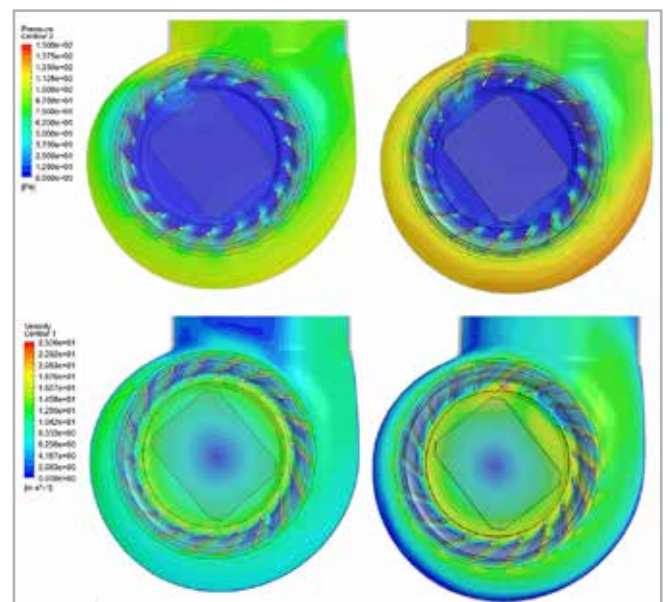

Fig. 3 - Comparison of pressure and velocity contours, current configuration on the left and optimized configuration on the right.

■ CASE STUDIES

The most relevant element in terms of FDE was a seal located at the top of the blades to reduce the mass flow rate of the by-pass flow between the rotational parts.

The best configuration obtained works at RPM values close to the point of maximum motor efficiency and a higher back pressure, as shown in Fig. 3. The back pressure value is about 10% higher than the previous one and, considering that the engine consumption remains almost unchanged, the FDE improvement is about 10%.

The positive result was analyzed with experimental tests in line with European standards; these tests included the volumetric airflow test (to obtain the P-Q curve) and the airborne acoustic noise test (to calculate the noise level). These activities were quick due to the rapid internal 3D prototyping. The figure below shows the comparison for the noise level and the volumetric air flow between the previous centrifugal fan unit and the optimized fan.

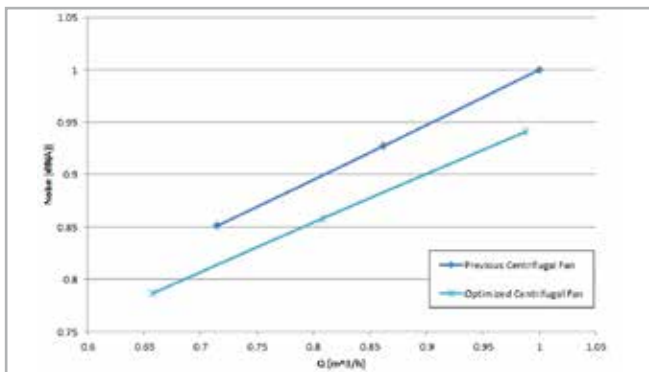

Fig. 4 - Noise-volumetric air flow comparison

At the same volumetric air flow value, the noise level decreased by about 6%. This is due to the smoother flow inside the fan, decreased by-pass flow (backflow) at the top of the impeller, and lower RPM.

Thermal and structural analysis

To ensure that the products comply with European regulations and internal procedures, a thermal and structural analysis had to be performed.

These static analyses were intended to determine the stress state of the plastic product (considering all the safety coefficients). The mechanical properties of the plastic material were calculated at different temperatures using experimental tests. The material is considered to be linear, elastic and isotropic. In the first part of this study, thermal analyses were performed for the plastic parts of the fan and for the impeller. In addition, the maximum RPM rotational force of the impeller was considered. The comparison between the previous and the improved geometric parts is shown in figure 5.

In the last part of the study, a static analysis of the product was conducted to simulate the deceleration that occurs during a drop test. During the drop test, the hood was dropped in three directions of drop from a height calculated according to the weight of the

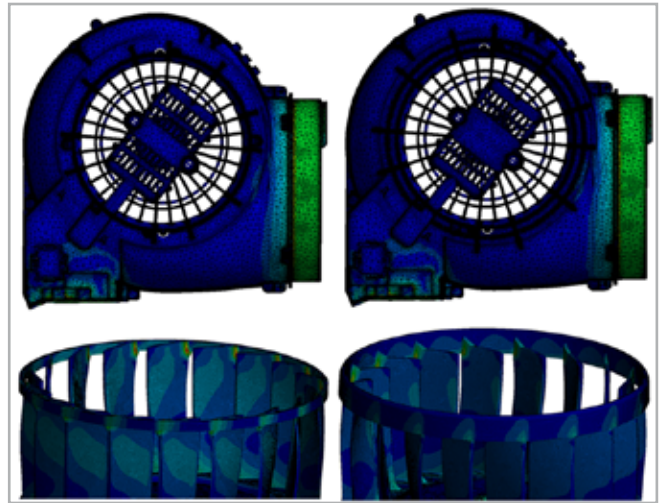

Fig. 5 - The equivalent (Von-Mises) stress analysis comparison

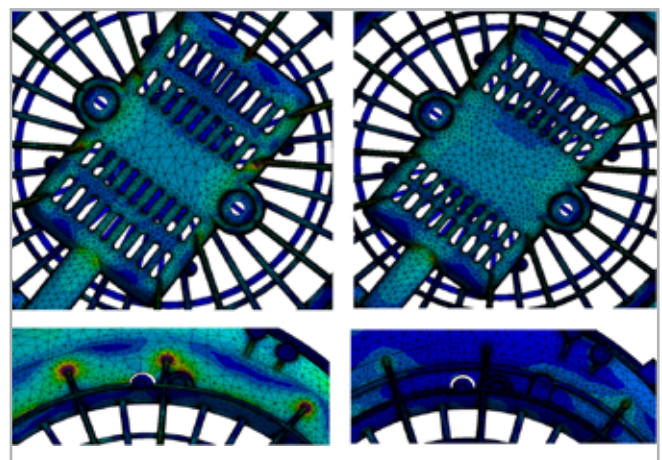

Fig. 6 - The equivalent (Von-Mises) Stress analysis comparison

product (hood plus packaging). From the latest experimental tests, the deceleration experienced by the engine is around 40g.

The results proved that the simulation reduced the maximum stress values of the plastic parts by making several modifications between the previous and the upgraded product, as shown in figure 6.

Conclusions

It is essential for companies today to remain competitive in the market. Numerical analysis plays a key role in achieving this goal. This study is an example of how it minimizes trial and error activities and costs and improves RFT – “right first time” – results.

In addition, through CFD simulation, the FDE of the centrifugal fan unit was increased by around 10% while the noise level decreased by around 6% without any additional costs for the motor. Moreover, the maximum stress values decreased for both operating conditions and during drop tests.

For more information
Andrea Rapisarda - Faber
andrea.rapisarda@faberspa.com



35th International CAE Conference

Themed around SBES and Digital Transformation, attracts 1,500 High-Level Engineers



The 35th International CAE Conference was held in Vicenza, Italy from 28-29 October 2019. This annual conference focuses on the business and technology issues in the Simulation-based Engineering Sciences (SBES) arena and draws delegates from worldwide industry sectors, ranging from aerospace and oil and gas to civil engineering, manufacturing, and automotive. An innovation this year was the launch of an independent exhibition associated to the conference and focusing on all the technologies, service providers and applications that are interconnected with the digital transformation of businesses as they move towards Industry 4.0.

Mr Stefano Odorizzi, CEO of the Italian-based international engineering simulation consulting firm, EnginSoft, key sponsors and coordinators of the conference and exhibition, stated, *“Increasing focus on Industry 4.0 requires companies and manufacturers of all sectors and sizes to begin a digitalization process if they wish to*

remain relevant and competitive in the global market today. Beyond the short-term business benefits to be gained, such as lower costs, increased innovation and improved productivity, a consensus that emerged from the many sessions at the event is that digitalization is also fundamental to enable organizations respond to and engage with the epochal changes that we are facing as human kind, while also addressing the traditional business challenges.”

This event’s theme this year was **“The engineering simulation path to digital transformation”** and attracted around 1,500 delegates from Europe, the Middle East, Asia, the USA and Africa. More than 100 speakers and over 70 exhibitors and sponsors from different industry sectors participated and the event was endorsed by NAFEMS and SIMAI as well as featuring events by APRE and SMACT and a specific Round Table session hosted by outstanding female engineers which discussed ways to attract more girls and women to the STEM subjects and the engineering disciplines in general.





The Plenary session of the conference spoke about the challenges and opportunities of digital transformation projects in various industry sectors as well as the role of digital transformation in assisting organizations to address market demand for greater environmental sustainability while also delivering improvements in product innovation, performance and efficiency, reducing costs in manufacturing, and assisting with predictive maintenance. The exhibition area showcased the technologies and services of all the big brands in computer-aided engineering such as ANSYS, Siemens, Altair, and Exagon, a range of vertical technologies including RecurDyn, Particleworks, Flownex and Volta, digital twin technology vendors such as LPH, Antemotion, and CIS, as well as emerging and new products on the landscape as the move to industry 4.0 generates products and services to respond to market demand.

The Research Agorà, an important forum and feature of the annual International CAE Conference dedicated to Research Project Consortia, this year featured 15 projects in work safety, fleet management, aerospace, biomedicine, robotics, manufacturing, electric vehicles, high performance computing and artificial intelligence.

A further annual initiative of the conference is the Poster Awards, a contest open to all students, graduates, researchers and faculty members from academic institutes and research centres with the dual purposes of recognizing excellence and innovation, and bridging the



gap between academia and industry. *“Growing collaboration between academia and industry and public institutions is fundamental to create a cohesive and credible response to today’s urgent challenges. The Poster Awards are just one more area where the International CAE Conference facilitates and supports these initiatives. This year 49 projects were selected, over 6,500 votes were received online for the projects and the five finalists were selected by a panel of judges from industry and academia,”* stated Odorizzi.

“This event, which to the best of my knowledge is the longest running in this sector and which this year saw the launch of the most comprehensive exhibition of technologies, products and service providers in the SBES and allied areas, has become an increasingly important event on the calendar for engineers to network, update their skills and deepen their knowledge of the latest technology developments and industry trends, as well as to engage with the important transformational issues we currently face. The spirited participation in the various sessions prove the validity of the event,” he concluded.



About EnginSoft

EnginSoft, established in 1984, is a premier consulting firm in the field of Simulation Based Engineering Science (SBES) with a global presence. Throughout its long history it has been at the forefront of technological innovation and remains a catalyst for change in the way SBES and CAE technologies are applied to solve even the most complex industrial problems with a high degree of reliability. Today, EnginSoft is comprised of groups of highly qualified engineers, with expertise in a variety of engineering simulation technologies including FEM Analysis and CFD, working in synergic companies across the globe.

EnginSoft is present in Italy, France, Germany, UK, Sweden, Turkey and the U.S.A. and has a close partnership with synergetic companies located in Greece, Israel, Portugal, Brazil, Japan and the U.S.A. It works across a broad range of industries that include the automotive, aerospace, defense, energy, civil engineering, consumer goods and biomechanics industries to help them get the most out of existing engineering simulation technologies. Learn more at www.enginsoft.com



Effectively digitalizing businesses

The routes mapped out by SMACT, the Triveneto Competence Center

As part of the Italian National Plan for Enterprise 4.0, provision was made for the creation of several Competence Centers: structures that bring together the worlds of industry and academia, with the intentions of promoting awareness of the 4.0 technologies, developing the necessary technical and managerial skills, and encouraging technology transfer to businesses through innovation projects. SMACT is the competence center based in the Triveneto region of north eastern Italy. SMACT is an acronym for the technologies on which it is focused, namely: **Social networks, Mobile platforms and apps, Advanced analytics and big data, the Cloud and the Internet of Things.**

At the 2019 International CAE Conference, SMACT presented itself and its intended role, as well as its vision for the effective digitalization of businesses. On introducing SMACT, Daniele Finocchiaro, Chairman of the Technical Group for Research and Innovation at Confindustria, Chairman of the AGSM Groups in Verona, Chairman of the Board of Directors of the University of Trento and Chairman of the Supervisory Board of SMACT, stated, *“Italy is the second largest manufacturing power in Europe, a position it created with tradition. Now, it must transform through*

digitalization, especially SMEs. SMACT is a great opportunity to create a national competence center that gives Italy the opportunity to play an important role in Europe.”

Fabrizio Dughiero, Chairman of the Management Board of SMACT, further explained that SMACT will target projects with a high Technology Readiness Level (TRL) of between 5 and 8. He pointed out that the Ministry of Italy required three live demonstration sites to illustrate the potential of these projects. These demonstration sites are in AgriFood, in mechatronics and the Digital Twin: the agrifood demo site is TransFood and is based in Padua and Verona and showcases digital production chains in agrifood; the mechatronics and automation demo site is Robo3D, based in Rovereto (a town near Trento in northern Italy) and showcases digital factories; and the digital twin demo site and is based at the Odyssey project, in Trieste and Udine. Dughiero explained that one of SMACT’s strengths is that it has brought together all the universities of the Triveneto region, as well as the National Institute for Nuclear Physics (INFN) and the Bruno Kessler Foundation, a top non-profit Italian research institute. *“SMACT’s political objective is to demonstrate that the strength of*

SMACT
Competence Center

INTERNATIONAL CAE CONFERENCE

union is feasible. Furthermore, it will not rely only on public funds, but is actively seeking private funds to increase its reach."

Matteo Faggin, Management Consultant at SMACT, described SMACT's vision and role in greater detail: *"In 2016, the Italian government, via its Ministry of Industrial and Economic Development (MISE) and its Ministry of Education, University and Research (MIUR), like many other countries around the world, launched a Multiannual Action Plan on Industry 4.0 (2017 - 2020) to promote the modernization of the country in terms of industrial processes and strategies by exploiting the latest technologies, including digitalization and the Internet of Things. Within the Italian network for Industry 4.0, the competence centers have a vertical specialization which involves higher education and the development of industrial research and experimental development projects by means of assessment of enterprises, advanced training, demonstration sites and Institute for Research on Innovation and Services for Development (IRISS) projects. The SMACT is one of eight Competence Centers based around Italy, each with its own technological/sectoral focus."*

Faggin explained that SMACT focuses on a range of Industry 4.0 technologies, specifically:

- S. - Social networks for engagement and data generation
- M. - Mobile as a platform for connecting people and assets
- A. - Analytics and big data to store information and contribute intelligence
- C. - the Cloud as a platform for data storage and sharing
- T. - The Internet of Things to connect products, processes and change business models

All of which are underpinned by the artificial intelligence of things (AIoT) as a driver of innovation from the fusion of the existing technologies today.

Faggin then presented the announcement of the call for proposals for financing from SMACT for IRISS projects (Innovation and Industrial Research and Experimental Development Projects) which closed on 29 November 2019 and for which it has allocated Euro 1.8 million to assist successful applying enterprises, particularly SMEs, in projects of digitalization. Open to all companies in Italy, the funding will be assigned by January/February 2020 to the successful proposals.

These presentations were followed by a round table discussion between entrepreneurs, managers, and representatives of universities, institutions and associations collaborating with SMACT.

Laura Bruni, strategy director for development plan and influence at Schneider Electric, a multinational company based in Italy, with 600m in turnover explained that Schneider Electric is participating in SMACT because they believe that innovation in Italy is not a one-man job: *"Anyone who does not digitalize in the coming months and years will become irrelevant,"* Bruni stated.

The Eight Competence Centers

CIM 4.0

Based in Turin at the Polytechnic of Turin
Technological focus: Advanced Manufacturing
Sectoral focus: Aerospace and Automotive
Live Demo: Additive Manufacturing + Academy

SMACT

Headquartered in Venice but present throughout the Triveneto region
Technological focus: S.M.A.R.T (Social Networks, Mobile, Advanced Analytics and Big Data, Cloud, Internet of Things)
Sectoral focus: Manufacturing, AgriFood, Living
Live Demo: Digital production chain in Agrifood, Mechatronics and Automation, Digital twin

Start 4.0

Based in Genoa and at the National Research Council (CNR)
Technological focus: Cybersecurity, safety, security
Sectoral focus: Ports, Energy, Transport
Live Demo: Port lab 4.0 (CNR)

Made 4.0

Based in Milan at the Politecnico di Milan
Technological focus: Cyberphysical Systems for Manufacturers
Live Demo: Polytechnic of Milan's Bovisa Campus – technological islands for industry 4.0 manufacturing technologies

BI-REX

Based in Bologna at the University of Bologna
Technological focus: Advanced Manufacturing and Big Data
Live Demo: AddMan pilot line, Robotics, Big Data

Artes 4.0

Based in Pontedera, Pisa at the St. Anna School of Advanced Studies
Technological focus: Advanced Robotics and Technologies
Live Demo: Robotics and microtechnology

Cyber 4.0 (still to be set up)

To be based in Rome at the Sapienza University

MediTech 4.0 (consortium constituted and under negotiation)

To be based in Naples at the Federico II University



The S.M.A.C.T. Technologies

S = Social networks – Corporate Social Identity, Reputation, CRM, Strategic Innovation, Open Innovation, Technical Assistance, User Experience trends, Crowdsourcing

M = Mobile – Low Power Chipsets, Security, Services Integration, I4.0 Mobile Interfaces, Augmented Reality/Virtual Reality, 5G, Wireless Protocols

A = Analytics and big data – Predictive/Machine Learning; Distributed Data; Data Virtualization, Integration & Quality; Simulation; 3D; HPC and HTP applications

C = Cloud – Distributed and Federated; Advanced Storage; Software and Platform as a Service; Server-fault-tolerant software-defined networks; Security

T = IOT – Embedded Systems, Additive Manufacturing, Smart Objects, Wireless Network Sensors and Objects, IoT Platforms



(INFN),” she said. “Through them, Italy must develop the critical mass to become protagonists in Europe and in the world.”

Gianluigi Morselli, member of SMACT’s management board and legal counsel for Southern Europe and Africa for Finnish company Wärtsilä, which has a turnover of Euros 6 billion, and was responsible for the digitalization of navigation and the management of the port in Trieste, stated that, once entrepreneurs understand SMACT’s services, the competence center’s real value will lie in its ability to put them in touch with the right experts in a short time.

Roberto Siagri, President and Managing Director of Eurotech, which works with the global 5000 companies, concluded that the current transformation underway is long-term and epochal, so that one cannot remain outside of it. “*Collaboration with universities in Europe has not gone well and Europe lags behind in innovation and technological development. However, digitalization is not expensive compared to past investments. What is needed instead is a cultural transformation in manufacturing and business. It is very important to talk about this and not only about technology. Italian companies need to understand that they do not sell products, but they sell their ability to make those products.*”

For more information

Angelo Messina - EnginSoft

a.messina@enginsoft.com

Alfredo Maglione, president of the Optoi / Industrio group, which was born from a spinoff of the Bruno Kessler Foundation 20 years ago, stated, “SMACT is an important opportunity for Italian enterprises. The Italian National Plan for Enterprise 4.0 was designed to bridge the gap between universities and businesses. While there are some examples in Italy, these are not at the level that you find in technologically advanced countries such as Germany, China, and the USA,” he stated. “*As a whole, Italians do not understand the importance of working in a team to create synergies for the benefit of all, which is a big limiting factor for Italy because, in general, everyone thinks in individual terms only,*” he continued. Michele Bugliesi, Rector of the University Ca’Foscari in Venice commented that SMACT could be a bridge to allow academia, research, business and entrepreneurs to begin talking and collaborating. Flavio Deflorian, Prorector of Trento University and a member of SMACT’s management board, agreed that collaboration and dialogue between universities and research centers, and enterprise and industry was essential to move Italy forward.

Nicoletta Amodio, manager for industry and innovation in Confindustria’s Industrial policy area commented that Italy’s underlying cultural problem is one of mentality. “*The Competence Centers are envisaged as national aggregations around various themes and must become a reference system on the topic in which they specialize, like the National Institute for Nuclear Physics*





International CAE Conference Round Table on women in engineering makes waves

Sky, Earth, Sea event places spotlight on extraordinary international achievements of women engineers

By Kathleen Grant

The afternoon of the first day of the 2019 International CAE Conference featured a special round table event entitled “Cielo, Terra e Mare: quando l’ingegneria al femminile non ha limiti” (SKY, EARTH, SEA: female engineers have no limits).

Featuring the participation of seven extraordinary female engineers and several other important female guests, the round table was conceptualized and organized by Silvia Di Rosa, Coordinator for Sales Operations and Product Managers at EnginSoft Italy who explained, *“I wanted to present a round table of women engineers who have overcome the challenges and achieved extraordinary levels of success, by any standard.”*

The event was introduced by Luca Scappini, a councillor of the Italian National Council of Italian Engineers, who stated: *“The engineering world is talking more and more about female engineers, not just in terms of pink quotas, but in terms of their merit.”* He was followed by Pietro Paolo Lucente, president of the Council of the Vicenza Association of Engineers, who added: *“Men are more closed. Women engineers have more open minds that lead to growth.”*

Stefano Odorizzi, CEO of EnginSoft, key sponsors of the round table, commented: *“EnginSoft is proud to state that 25% of its engineers are women, compared to the 19% of Italian engineers in the market in 2019.”*

The opening statement of the event was made by Amalia Ercoli Finzi, Italy’s primary aeronautical expert, technical consultant to NASA and to the European Space Agency (ESA). Finzi, who graduated in Aeronautical Engineering, has been working in the field of space flight dynamics and space mission design for over twenty-five years. She has contributed to the creation of satellites and probes for planetary exploration and has held positions at the Italian Space Agency, the European Space Agency and the International Astronautical Federation. She was responsible for the SD2 experiment of the European Rosetta mission to the Churyumov-Gerasimenko comet to drill and collect samples from the cometary nucleus, is director of the Department of Aerospace Engineering of the Politecnico di Milano, Italian delegate for the European Horizon 2020 “Space configuration” program, and she has received the President of the Republic of Italy’s gold medal for scientific merit.

Finzi was followed by Maria Antonietta Perino, Director of International Network Opportunities Development for Thales Alenia Space in Turin. Perino is a nuclear engineer and member of the Academic Council of the International Space University at M.I.T., Boston, USA; she is a member of several scientific committees in the space sector, a member of the EuroScience Open Forum (ESOF), and of Women in Aerospace, as well as of the Académie de l'Air et de l'Espace and the International Academy of Astronautics. She has been Vice-President of the International Astronautical Federation and is president of Explore Mars Europe. She has received a Distinguished Service Award from the International Astronautical Federation and was awarded the Star of Merit for Work in 2019. *"Exploring space, we go in search of possible answers to "The Big Why's": Who are we? Where do we come from? Are we alone in the Universe? It is absolutely fascinating, and I am lucky because I do it every day. Just as we work well in families when we collaborate, so too, in the field of work we obtain results more easily when there is concurrence of skills, perceptions and vision from different players – male, female; Italian, American, Russian; engineer, doctor, psychologist; and so on. These are interdisciplinary, international missions where the fact of being a man or woman should not matter much,"* she said. Her main message to the women in the audience was to never give up.

Also participating via satellite link was Chiara Montanari, self-proclaimed "life explorer", owner and founder of the Milan-based consulting firm "Complexity Aware" which supports companies interested in awakening the so-called "Antarctic Mindset",

or the ability to create strategies to thrive in uncertainty, and which promotes a method developed in collaboration with the scientific philosopher Gianluca Bocchi. Montanari has 16 years of experience in managing and organizing polar missions, she was the first Italian to lead a mission in Antarctica and currently has five active international missions. She has represented not only Italy, but also France and Belgium, managing research bases in some of the most extreme locations on the planet (the Base Concordia, for example, is located at 400m altitude where temperatures are between -50°C in summer and -80°C in winter and which at 1,200km from the coast is completely isolated. The 80-strong team at the base has to run a variety of projects under extreme conditions and is also studied by the European Space Agency in anticipation of future long-term space expeditions). In addition to other activities in sustainability and innovation, for some years now she has focused her activities on leadership and the operational effectiveness of multidisciplinary teams involved in complex projects and in contexts of accelerated change (including technological innovation, new global scenarios, and climate change). In 2014 she was awarded the Ambrogino d'Oro for her commitment to Innovation and Technology Transfer, was included by Forbes Italy in its 2018 list of the "100 winning Italians", and was recognized by Startup Italy in 2019 as one of the 150 women who "contribute significantly to the innovation of our country". In 2015, she published a book with Mondadori Publishers called "Cronache dai Ghiacci" (Chronicles from the Ice), in which she proposed the idea that the contemporary world is becoming more and more similar to Antarctica with its high complexity, high risk and permanent uncertainty.

Alessandra Cenicola, Chassis Program Manager Team Leader at Scuderia Ferrari where she works in the Formula 1 racing management team, also participated in the Round Table. Cenicola graduated with a master's degree in Automotive Engineering from the Politecnico di Turin and joined Ferrari in Maranello as a "composite" department of the racing management team as a Composite Quality assistant. Over the years, she has taken on increasing responsibility, dealing with the Formula 1 cars from their birth in the laboratory through to their performance on the racetrack. Today, she coordinates a transverse team of engineers who develop programs for defining and updating the entire chassis area for F1 cars during the season, from the chassis, suspensions, systems and gearbox to the aerodynamic components, such as the wings, nose, bodywork and underbody. At Scuderia Ferrari she has transformed the passion for cars, competitions and speed inherited from her father, a great Formula 1 fan, into a career. Born in Lucera, Apulia, she received the Argos Hippium Award in 2013, which is given to the most deserving personalities of the Apulia region. "My story began when I was a child and had a great passion for everything technical, especially for cars. I would talk about the roar of my father's car engine that I heard in the garage. I loved speed and racing and so I was a connected to a not entirely feminine stereotype. I tried not to let myself be conditioned by the social fabric and tried to find my way by undertaking a degree in





vehicle engineering, after which I joined Ferrari where I practically grew up professionally, in many different roles,” she explained. Her message to the audience was that engineers need a strong technical foundation and the ability to work in a team.

Alessandra Angelini, an aerospace engineer from Rome, presented the three-year restoration project of an 10m international tonnage vintage Olympic sailing boat, Marga 1910. Almost 16m long, with mahogany planks and a majestic sale, this yacht was designed by C.O. Liljegren, a Scandinavian designer, and launched by the Hästholm shipyard in Stockholm 107 years ago. *“The restoration lasted three years, we respected the original project down to the single rivet, only adding the engine,”* Angelini explained. Once restored, Angelini used it to participate in the 2012 Stockholm Olympics. Angelini is one of very few female vintage sailing boat owners in the world. In addition to participating in two Olympics, London 2012 and Rio 2015, in the sailing championships, she also participates in La Sapienza University’s projects Mille e Una Vela (A Thousand and One Sails), Sapienza Corse (Sapienza racing for prototypes of Formula One vehicles), and Sapienza Volo (Sapienza Flight for prototypes of small Cessna airplanes). In December 2014, she began a three-year collaboration with Rolls Royce Aerospace in Virginia, USA, supervising the design of the Trent 1000TEN engine. She returned to Italy in March 2017, to oversee her family’s four wineries and the family hotel in Tuscany.

Monica Valli, VP of Operations for D-Orbit, a company that operates in the aerospace sector in Italy, also spoke. D-Orbit’s solutions include mission analysis and design, engineering, manufacturing, integration, testing, launch, and end-of-life decommissioning. It offers launch and deployment services for satellites, from the launch procurement of a single spacecraft using standard deployment strategies to the precise deployment of a full constellation with ION CubeSat Carrier, a free-flying dispenser developed and operated by D-Orbit.

She stated: *“Today, I spoke about my experience of the daily challenges of working as a small innovative company in a large industry sector – the daily challenges include staying on the*

market and managing teams that are diverse and varied in terms of experience, seniority and skills.”

Also participating were Linda Serra, CEO and co-founder of Work Wide Women, a startup that initially specialized in empowering women, striving to increase the number of women in ICT and the STEM professions; Odile Robotti, founder and MD of Learning Edge/Talent Edge, and author of the books *“Il Talento delle Donne”* (The Talent of Women) published by Sperling & Kupfer in September 2013, and *“Il Magico Potere di Ricominciare”* (The Magical Power of Starting Again), published by Mind Edizioni in 2019 as well as being the author of many articles on organizational talent, inclusion, women’s leadership and inter-generational collaboration; and Elena Donazzan, Regional Councillor for Equal Opportunities for the Veneto Region. Donazzan said: *“When an organized world includes the greater involvement of women, it produces extraordinary results. A study conducted by the Region of Veneto after the economic crisis found that the companies that failed less had a woman at the helm. At the same time, we definitely have a problem in Italy with the STEM subjects and with the approach to science in general, particularly for the female universe. There is a problem with programs and programming that should rather take into account precisely these issues and strive to have as testimonials intelligent women like those that presented today.”*

“While there was a disappointing turnout in the conference hall, the event was enormously successful in the media. Furthermore, the Assessor of the Veneto Region has invited us to participate in other events for the Veneto region. The participants formed a friendship during the event around the common goal of generating enthusiasm for STEM among women of the future. This “Sky, land and sea” event has created a brand that will produce further content in future International CAE Conference events. The shared qualities represented by the women engineers that participated today were tenacity, courage and determination. This is what is necessary among women engineers, as well as the ability to open their minds to the unknown,” Di Rosa concluded.



The 2019 International CAE Conference Poster Awards

Awarding innovation among engineering students and bridging the gap between academia and industry



The “Poster Award” is an initiative to help disseminate the culture of engineering simulation. The contest recognizes and rewards the use of CAE Technology, through creatively illustrated posters. The purpose of the contest is twofold:

- to recognize excellence and innovation within academic projects;
- to bridge the gap between the academic and industrial world.

The contest is open to students, graduates, researchers, and / or faculty members, such as professors, from Universities and Research Centers.

The winners were chosen by means of a two-phase adjudication process: online voting and a technical judges panel. Five winners

were announced at a prize-giving event on the first evening of the 2019 CAE Conference and Exhibition. They were, in no specific order:

- In Civil Engineering - *Numerical Analysis of Bicycle Helmet Impacts using Biomechanical Metrics*, a project from the Department of Mechanical Engineering at University Carlos III of Madrid in collaboration with Japan Automobile Research Institute.
- In Additive Manufacturing - *Design Workflow for Additive Manufacturing*, a project from the University of Padua.
- In Architecture and Cultural Heritage - *Great statues and seismic vulnerability, a photogrammetric approach for early safeguard*, a project from the University of Florence.
- In Energy – *The Swiss AA-CAES pilot plant: CFD modeling and validation of the TES system*, a project from SUPSI - DTI – MEMTi, in collaboration with ETHZ
- In Mechanics – *A Study of a Rover Wheel for Martian Explorations, Based on a Flexible Multibody Approach*, a project from the Politecnico of Turin in collaboration with Thales Alenia Space Italia



The sponsors of this year's event were

Congratulations to all the winners!



Design workflow for Additive Manufacturing

1222-2022
800
ANNI



UNIVERSITÀ
DEGLI STUDI
DI PADOVA

By F. Uriati, S. Rosso, F. Da Rin Betta, G. Savio, R. Meneghello, G. Concheri
Università degli Studi di Padova

Introduction

Additive Manufacturing (AM) technologies introduce a completely new approach for the design of customized and optimized parts. Optimization approaches such as size, shape, and topology optimization are being re-discovered, since the models resulting from these methods are challenging to produce with traditional manufacturing techniques. These methods enable designers to reinvent solutions for different structural problems with the aim of obtaining improved mechanical characteristics and higher overall performance, especially the reduction of weight that comes with these new geometries; moreover, from an environmental point of view, AM techniques guarantee a low impact, due to volume reduction during the modeling phase and the reduction of material waste during the manufacturing process.

To exploit these opportunities, the Laboratory of Design Tools and Methods of Industrial Engineering of the University of Padova proposed a design workflow suitable for AM.

Design workflow

First, a design space is selected in a solid model. Then, it is possible to choose between two branches: topology optimization and size optimization.

In a topology optimization algorithm, material is arranged in the design space in order to find the best distribution under a set of boundary conditions. The goal of the optimization can be the maximization of stiffness, imposing a desired reduction of mass. As a result, a density map is obtained, which is contoured to a

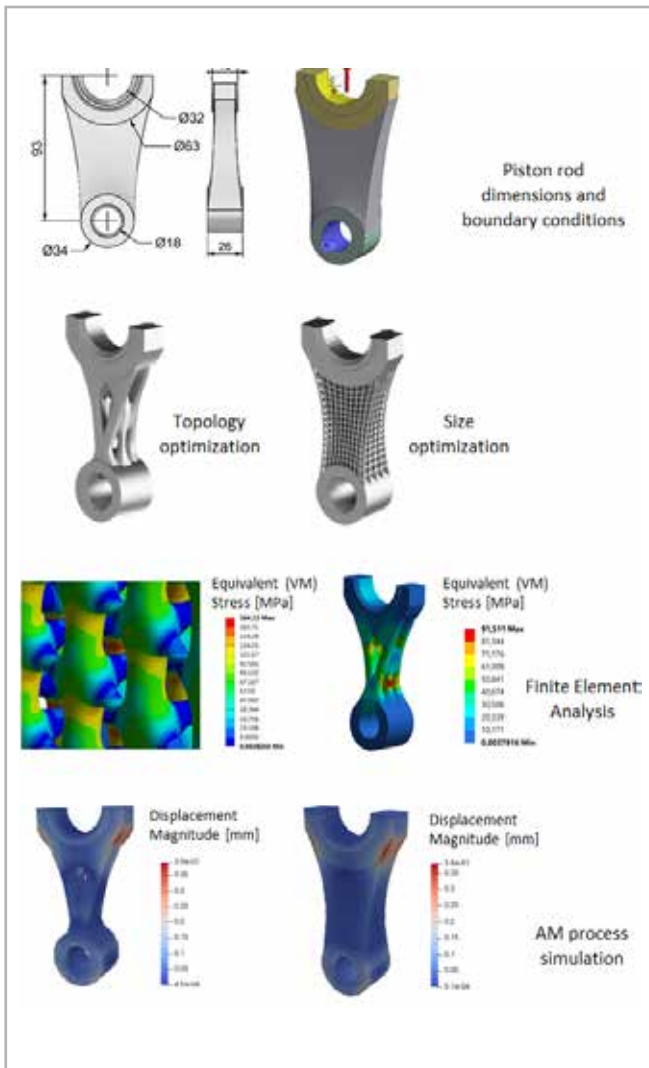

specific level of density (threshold), obtaining a mesh surface. The optimized mesh in the design space is taken as “inspiration” for the further modeling of the part in a CAD environment, often operated manually.

If a size optimization is performed, a conformal wireframe is obtained specifying the unit cell type and the minimum cell size; then, a size optimization is performed taking into consideration boundary conditions and manufacturing constraints. As a result, the optimal diameter of each beam is obtained. A lattice structure is then modeled from the wireframe and from the optimized

diameters with a mesh modeling method. A subdivision surface algorithm is finally applied to automatically obtain smooth surfaces; this allows the stress concentration to be reduced, especially at nodal points, enhancing the mechanical properties and the fatigue life of the lattice.

Regardless of the type of optimization chosen, simulation software is used in different phases of the design process. During optimization, fixed element analyses (FEAs) are iteratively performed to reach the optimization target. At the end of the modeling phase, a FEA is performed to investigate the mechanical properties of the final part. The validated model undergoes an AM process simulation to evaluate possible issues that could occur during the manufacturing phase, i.e. thermal deformation and residual stress.

Case study, discussion and conclusions

The case study presented is a piston rod in aluminum alloy. Starting from a simplified design space, the design workflow is validated adopting both the optimization approaches.

Both the approaches present pros and cons. Topology optimization can be performed using commercial software but requires a manual remodeling of the optimized part due to the coarse mesh resulting from the optimization. The second approach allows a size optimization of the lattice structures and the final mesh presents a smooth curvature (C2) thanks to the subdivision algorithm. These approaches, together with AM technology, allow lightweight structures, reducing mass and volume of the parts and leading to a low environmental impact.

“This work was partially funded by Fondazione CARIPARO, Cassa di Risparmio di Padova e Rovigo and the grant “FSE 2105-37-11-2018: Hybrid manufacturing strategies through selective laser sintering for the customization of series components” by Regione Veneto”

For more information

Stefano Rosso - Università degli Studi di Padova
stefano.rosso.3@phd.unipd.it

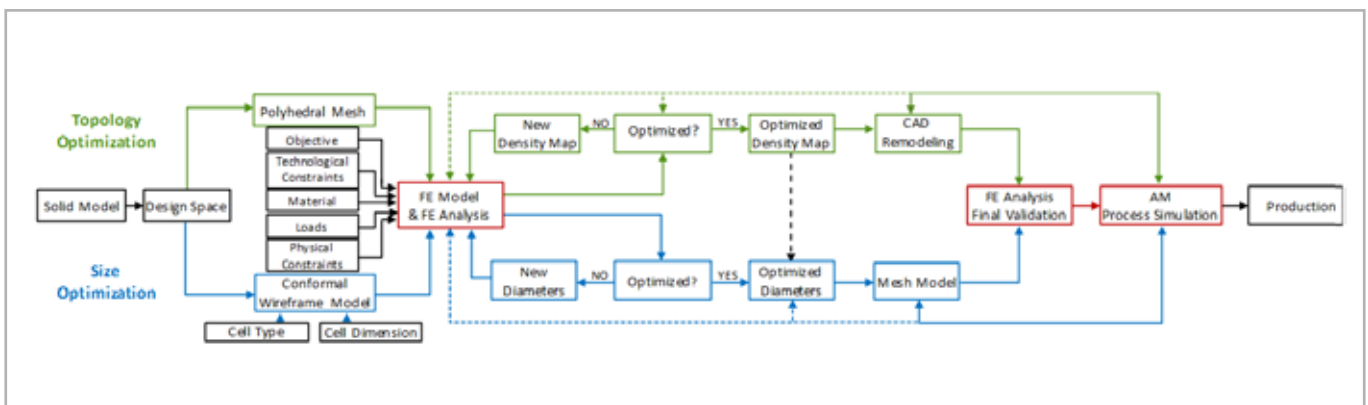



The Swiss AA-CAES pilot plant

CFD modeling and validation of the TES system

By **S. Zavattoni¹, J. Roncolato¹, L. Geissbühler², A. Haselbacher², G. Zanganeh³, A. Steinfeld², M.C. Barbato¹**

1. Department of Innovative Technologies, SUPSI - 2. Department of Mechanical and Process Engineering, ETH - 3. ALACAES SA

A valid alternative to pumped hydroelectric energy storage (PHES) is represented by compressed-air energy storage (CAES). Two industrial-scale CAES plants are nowadays successfully in operation: the 321 MW Huntorf plant (Germany) and the 110 MW McIntosh plant (USA). Their round-trip efficiencies, 42% and 54% respectively, are limited by the dissipation of the thermal energy produced during compression. Therefore fossil fuels are required to heat up the pressurized air before its expansion in the turbine [1].

Advanced adiabatic compressed air energy storage (AA-CAES)

To overcome the limitation of conventional CAES plants, the concept of AA-CAES was proposed (see Fig. 1). In this technology, thermal energy storage (TES) is exploited to store the thermal energy produced during compression to be recovered before the expansion. Although the AA-CAES concept is still in the research and development stage, the expected round-trip efficiency is in the order of 70%, compared to PHES [2].

Other advantages of AA-CAES, such as limited environmental impact and lower estimated capital costs, make this technology attractive as a potential alternative to PHES for achieving the long-term energy policy developed by the Swiss Federal Council (Energy strategy 2050).

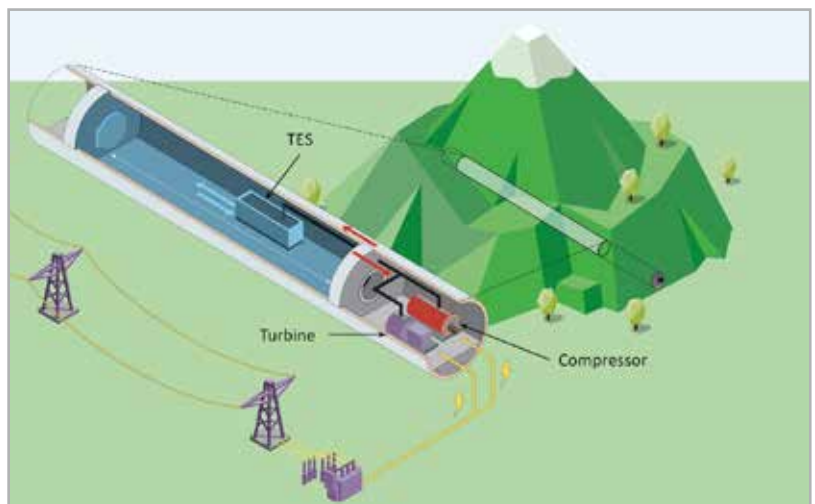

Fig. 1 - Example of an AA-CAES plant built in a lined tunnel. Image adapted from [3].

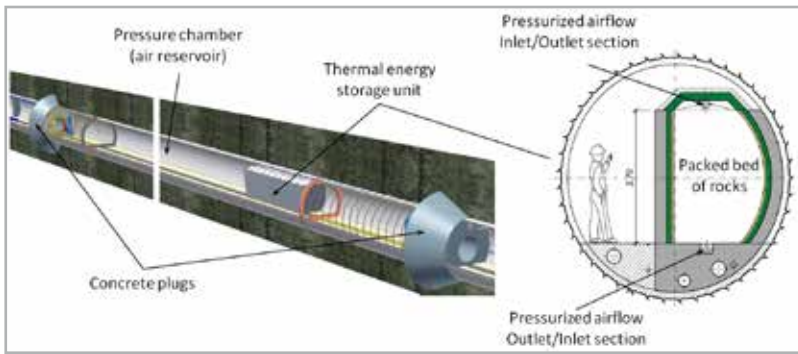

Fig. 2 - AA-CAES pilot plant layout (l.h.s.) and tunnel cross-section (r.h.s.). Courtesy of ALACAES SA.

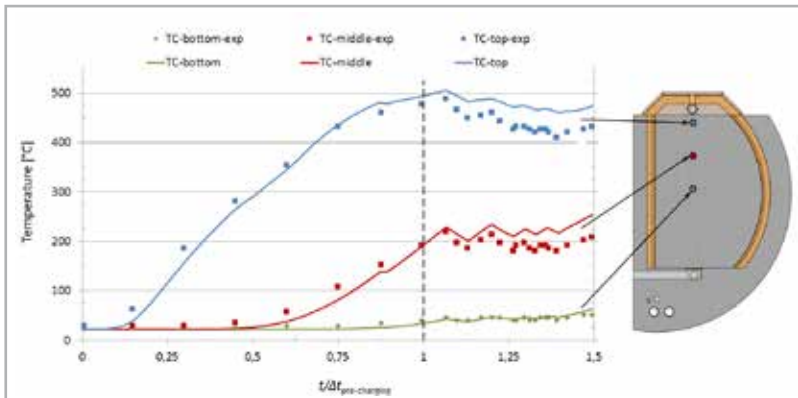

Fig. 3 - Comparison between CFD simulation results (solid lines) and experimental data (markers).

Pollegio AA-CAES pilot plant and experimental campaign

To evaluate the feasibility and applicability of the AA-CAES technology, a pilot plant was built, in a collaboration between ALACAES and ETHZ, in Pollegio (Ticino, Switzerland).

A segment of a tunnel located north of Biasca, previously used by the AlpTransit project, was exploited as a high-pressure air reservoir. The latter was enclosed by building two 5 m thick concrete plugs at the two ends of a 120 m long section (l.h.s. of Fig. 2). The pilot plant was designed to operate at pressures and temperatures up to 33 bar and 550°C respectively. A single-tank TES, based on a packed bed of natural rocks, was installed inside the pressure chamber. The volume of the packed bed is 44 m³ with an average particle diameter and void-fraction of 20 mm and 0.342 respectively.

An extensive experimental campaign was carried out on the pilot plant. The experimental data gathered in Pollegio were exploited to also evaluate the accuracy of the numerical models developed to simulate the real TES system behavior.

CFD numerical validation and conclusions

Since the TES can be considered the key component of AA-CAES technology, a CFD model was developed, to evaluate its thermo-fluid dynamics behavior, and experimentally validated. A schematic of the TES unit under investigation is reported in the r.h.s of Fig. 2.

The reference experimental campaign was characterized by a 42 h pre-charging, followed by five consecutive charge/discharge cycles. Fig. 3 shows the comparison between the simulation results and the experimental data gathered from some thermocouples located at different heights, into the packed bed. A fairly good agreement between the simulation results and the experimental temperatures can be observed demonstrating the effectiveness of the CFD model developed in replicating the thermo-fluid dynamics behavior of the experimental TES unit.

Fig. 4 depicts the temperature contours of the TES unit at different time intervals. Concerning the experiments, although the maximum pressure reached was limited to 6 bar, the TES system and the cavern performed properly. The estimated efficiency of the pilot plant was in the range of 0.65-0.79 while the thermal efficiency of the TES was between 0.75-0.89.

Acknowledgments

The financial support of the Swiss Commission for Technology and Innovation through the Swiss Competence Center in Energy Research (SCCER HaE - Heat and Electricity Storage) and SNF through NRP 70 (Grant N. 407040_154017) is gratefully acknowledged.

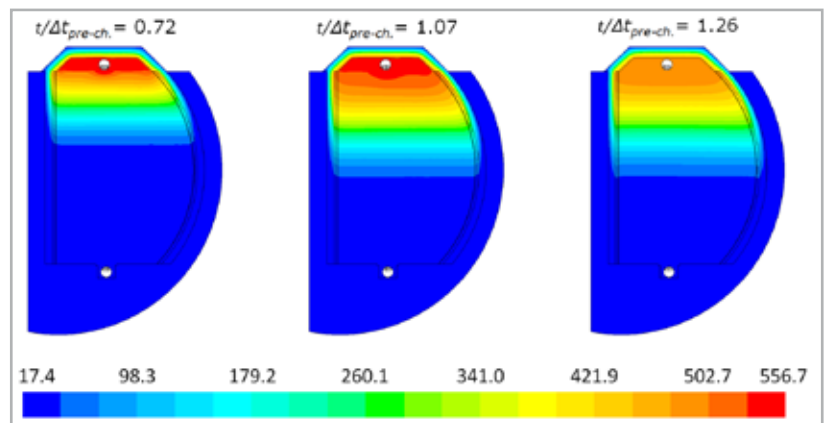

Fig. 4 - Contours of static temperature. Temperature values are in [°C].

References

- [1] M. Budt, D. Wolf, R. Span, J. Yan, "A review on compressed air energy storage: Basic principles, past milestones and recent developments", Applied Energy, vol. 170, pp. 250-268, 2016.
- [2] J. Roncolato, A. Pizzoferrato, V. Becattini, A. Haselbacher, G. Zanganeh, M.C. Barbato, "AA-CAES plant modelling in Simscape", International CAE Conference 2017, Vicenza, Italy.
- [3] Micha Treuhardt, "Druckluftbatterie in den Alpen", Tages-Anzeiger.

For more information
Jonathan Roncolato - Supsi
jonathan.roncolato@supsi.ch



Great Statues and Seismic Vulnerability

By Raffaella Paolucci,
Marco Tanganelli, and Giorgio Verdiani
Università degli Studi di Firenze



A Photogrammetric Approach for early Safeguarding

RESIMUS PROJECT

In recent years, increasing attention has been paid to creating safeguarding measures to protect masterpieces, art items, and large statues from the uncontrollable event of an earthquake. In this poster, a working method for simulating the effects of an earthquake and understanding the real state of safety of these artworks will be shown.

This work was developed within the RESIMUS Research Project: "RESIMUS, un progetto volto alla vulnerabilità sismica delle opere museali", whose multidisciplinary approach aims to combine different fields of knowledge to prevent risk to the museum's collections in case of earthquakes. The RESIMUS working method, characterized by

collaboration and comparison between different professions, was applied to Giambologna's statue of Oceano, now located under the vaults of the Bargello National Museum in Florence, and to the homonymous fountain in Boboli Garden, where it was originally placed.

DIGITAL SURVEY: PHOTGRAMMETRY AND LASER SCANNER

The seismic assessment of artifacts requires a preliminary representation of the object. Only an accurate representation can provide reliable results in terms of seismic assessment. With the cooperation of the Photographic Laboratory of the University of Florence, we conducted two photogrammetric surveys: one of the original copy of Oceano, placed in The National Museum of Bargello, and another one of the whole Fountain in Boboli Garden. In line with the procedures of Structure from Motion/ Image Matching (SfM/IM) software, the model of the fountain of Oceano here presented, was obtained using the software Reality Capture. It extracts the remarkable points from the photos, derives the photographic parameters and finally cross-references the recognizable points across several photos, finding the coordinates of the points in the space. Subsequently, the alignment of the chambers produces a 'dense' cloud of points, with a significantly high number of points. From the dense cloud, a mesh and then a UV mapping are created on which the texture of the object is generated and applied.

Since the initial phases of the survey, representation and reconstruction are so important for the subsequent steps, we decided to integrate the photogrammetric survey of the fountain with a laser scanned one to avoid as far as possible errors of representation and measurement due to the height of the sculptural complex.

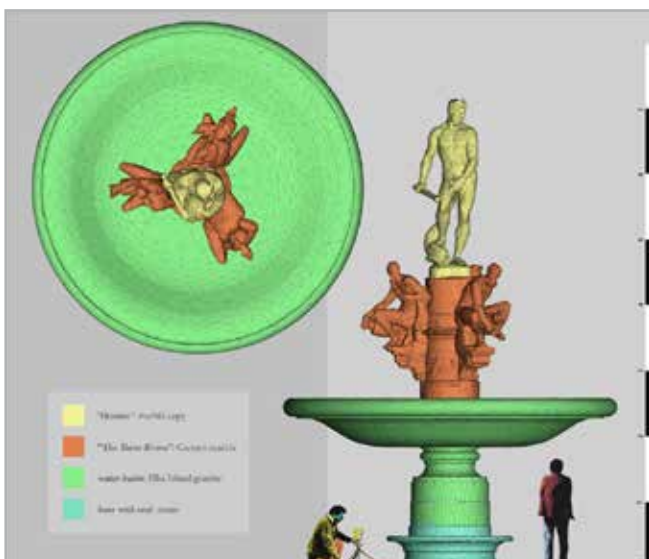

Fig.1 - Final simplified mesh model for seismic analysis.

MODELING: OPTIMIZATION FOR SEISMIC ANALYSIS

A FEM model to be used for structural analysis was obtained from the photogrammetric survey model by applying a series of transformations to it to render it suitable for easy analysis with calculation software. In the first step, the number of polygons was reduced from 2.000.000 to 23.200 triangular faces through the Quadratic Edge Collapse Decimation procedure in MeshLab software. Thereafter, the surface model was implemented and transformed into a volume model made of 125,600 solid tetrahedral faces with software Straus7.

SEISMIC ANALYSIS

Seismic analyses for proper weight, modal analysis and dynamic analysis were conducted. For the analysis for proper weight, the statue of the god, the group of the three Rivers, the granite basin and the stone base were taken as a single continuous body. In the lower part of the basement the X,Y,Z shifts were blocked to simulate a joint at the base. This hypothesis has allowed to evaluate the effects produced in linear elastic field by seismic actions in terms of stress states and displacements.

A modal analysis was also performed; it provided the natural frequencies of the main modes of vibration and was also useful for quantifying the alpha and beta coefficients, according to the classical formulation proposed by Rayleigh [Chopra 1995] to be used for dynamic analysis over time.

Finally, the dynamic analysis was performed to evaluate the possible response of the statue-pedestal as a single set. The seismic input was obtained through the database Itaca 2008, from 7 accelerograms of real seismic events, compatible with the elastic spectrum proposed by the Italian NTC2018 code for the site of Florence, with a soil type B and a return period of 1950 years. The dynamic analysis provided results both in terms of displacement and stress states. For all analysis, no significant displacements are ever achieved in the three main directions.

Linear analyses conducted here allowed us to highlight the areas in which the highest stress conditions are reached. In all analyses carried

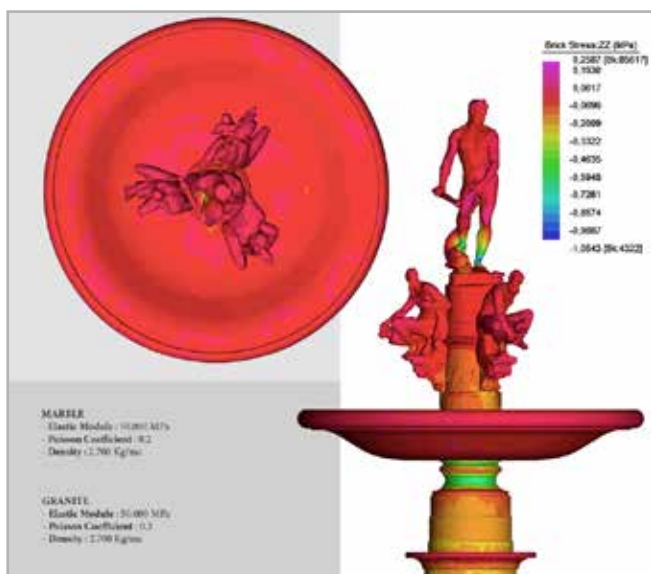

Fig.2 - Seismic analysis for proper weight.



Fig.3 - Augmented reality: projection of seismic analysis on 3D print

out, stress levels were concentrated in the area of the ankles. The results obtained allow a first evaluation of the elastic behavior of the statue; further modeling will be performed to consider the non-linear behavior of the materials and to insert the effect of non-linearity produced by the pedestal statue contact surface.

MULTIMEDIA PROJECT

At the end of this multidisciplinary survey aimed at using the correct RESIMUS working methodology, but trying to add something innovative to previous research, it was decided to illustrate the findings with a multimedia project. As a first step, a 3D print of the original Oceano copy was created in white photosensitive polymer resin, after the results obtained from the seismic analyses conducted with the dedicated calculation software were projected onto it. The final result is the ability to view the texture applied both to the model printed in 1:20 scale, and to the real Giambologna sculpture, via any mobile device.

CONCLUSIONS

Italy hosts a great quantity of fundamental important masterpieces of cultural heritage; their protection from natural events and disasters is important for the cultural and economic asset register of the country. The assessment of the seismic safety of art items such as marble statues, requires a complex series of procedures, which involve different research fields.

The analysis performed in our case study evidenced the importance of adopting the most recent technologies for performing the digital survey and for providing the geometrical data to be used for analysis. An accurate polygonal mesh forms the basis of advanced seismic analysis and, as shown in this paper, can give clear indications about the weakness and the potential risks from the possible evolutions/events that could afflict the statue.

For more information
 Raffaella Paolucci - Università degli Studi di Firenze
raffapaolucci@yahoo.it

The Research Agorà at the 2019 CAE Conference

The Research Agorà is the area dedicated to international Research Projects inside the International CAE Conference and Exhibition. It allows enterprise and university researchers to disseminate the concepts and the results of their projects. Already in its seventh edition, the Research Agorà hosts many innovative international projects every year, especially those co-funded by the EU and developed through outstanding and prestigious partnerships. This year's conference focused on digital transformation and the Research Agorà showcased 11 different projects from a variety of industry sectors. Synopses of these projects will be shared across this and the following issue of the Newsletter.



The quest to find a next-generation ADAS Simulation Framework

By Matteo Ragni, Luca Gasbarro
Antemotion

Today's commercially available vehicles integrate several Advanced Driver Assistance Systems (ADAS) and, even some Level 2 to 3 Autonomous Vehicles (AV) algorithms to improve transport efficiency and traffic safety.

Image generators (render engines), scenario simulators, multi-body dynamical solvers for vehicle dynamics, etc., cooperate and provide feedback in a computational environment with attached Software and Hardware loops (SiLs and HiLs respectively). Furthermore, if driver in the loop (DiL) becomes necessary, real-time, hard simulations are required to guarantee driver engagement and realism (e.g. including a sound generator in the loop). Such simulations are usually distributed across computational clusters – an exponentially complex scheme where communication bottlenecks impede real-time simulation and where the enormous quantity of data used and generated becomes rapidly unmanageable (see Fig. 1).



Fig. 1 - Each gray square represents a different software participant: the connections and data generated and used by the software rapidly becomes unmanageable



Fig. 2 - The Simulation Framework uses a common communication infrastructure or "Simulation Network" where each software connects through a Binding Node

A unifying Simulation Network can bring order to this co-simulation muddle (see Fig. 2). Based on the Robotic Operating System 2 (ROS 2) framework that uses the Data Distribution Service (DDS) standard, ROS 2 creates a dependable, high-performance, interoperable, real-time, and scalable data exchange framework with a publisher-subscriber mechanism to simplify complex network programming of heterogeneous systems. The framework also offers a variety of tunable and preset Quality of Service (QoS) policies to govern communication between network nodes according to the project objective(s). ROS 2 and DDS have been thoroughly investigated in literature [1], [2].

Each piece of the simulation connects to the Simulation Network via a simple translation layer called a Binding Node (see Fig. 3). This allows any software with an application programming interface (API) to be attached to the simulation network. Binding Nodes enable higher functionalities such as remote configuration, monitoring and service discovery. Each simulation node follows a well-defined simulation life cycle, depicted in Fig. 4.

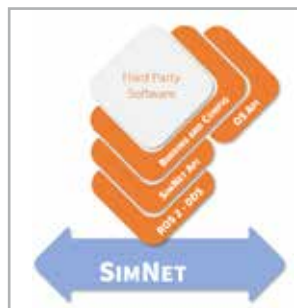

Fig 3 - The Binding leverages ROS 2 and DDS to add tools for higher level functionalities, such as node discovery, remote configuration and monitoring

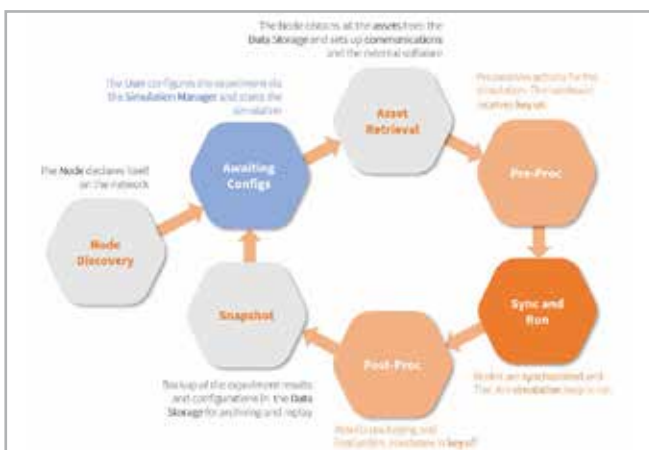

Fig. 4 - Nodes follow a well-defined simulation life cycle

The Simulation Network also allows management nodes to be introduced (see Fig. 5). The Simulation Manager acts as a remote configuration utility (cfr. Fig.6) and as a supervisor of the simulation process. The Asset Database, a reference database, is a centralized repository of data which is emitted as an asset before

References

[1] J. Kim, J. M. Smereka, C. Cheung, S. Nepal, and M. Grobler, "Security and performance considerations in ros 2: A balancing act," arXiv preprint arXiv:1809.09566, 2018.
 [2] Y. Maruyama, S. Kato, and T. Azumi, "Exploring the performance of ros 2," in Proceedings of the 13th International Conference on Embedded Software, EMSOFT '16, (New York, NY, USA), pp. 5:1–5:10, ACM, 2016.



Fig. 5 - The simulation framework allows the introduction of additional management nodes, such as the Simulation Manager and Asset Database



Fig. 6 - Configuration of a node through the Simulation Manager

the start of the simulation and ingested as a snapshot at the end of the simulation to automatically store and version each run. Cooperation between the Simulation Manager and Asset Database introduces some further higher level functionality: the Simulation Manager allows the creation of configuration presets in the Asset Database that enables coherent configuration of several simulation nodes (e.g. a specific driving environment requires render engines, traffic simulators, and tire-terrain contact solvers to be configured for the same environment; a configuration preset propagates assets coherently to all Nodes, avoiding configuration errors and reducing configuration effort). An early functional demo of the framework being used across a distributed environment with integrated SiL / HiL systems was presented at the CAE conference. The demo coupled a complete simulator with an nVidia XAVIER system executing lane identification like a Lane Departure Warning system (LDWS) system. Fig. 7 depicts the demo.



Fig. 7 - Demo of the AnteMotion framework at the Research Agora at the 2019 CAE Conference. An Image Generator in the simulator cluster generates a video feed for the nVidia Xavier System that is simulating an LDWS system. The driver in the loop can feel the torque on the steering wheel generated by the mockup of a real ADAS system

ODIN - CAD/CAE Integration in Orthodontic Device Innovation

The Project

The current requests for continuous innovation represent a challenge in every industry including the field of orthodontics. The main idea of the project was to propose an approach to design that can be used every time a biomedical device is developed, validating the hypothesis on a real case. More specifically, the aim of this project was to develop a systematic design methodology, adopt the most innovative CAD/CAE tools and use additive manufacturing techniques for the creation of a functional appliance to correct class II skeletal malocclusion.

The customer's requirements were identified by examining the existing devices and considering patient and dentist needs. Quality Function Deployment (QFD) was used to organize and analyze the acquired data. Systematic methods such as the morphological method, the theory of inventive problem solving (TRIZ), biomimicry and other creative methods were used to guide the generation of ideas and concepts.

Morphometrics data is then extracted from RX, video tracking and dental scans, and used as input to develop a patient-specific appliance. By processing the data virtually, the mandible position and motion is assessed. The orthodontist suggests how to correct

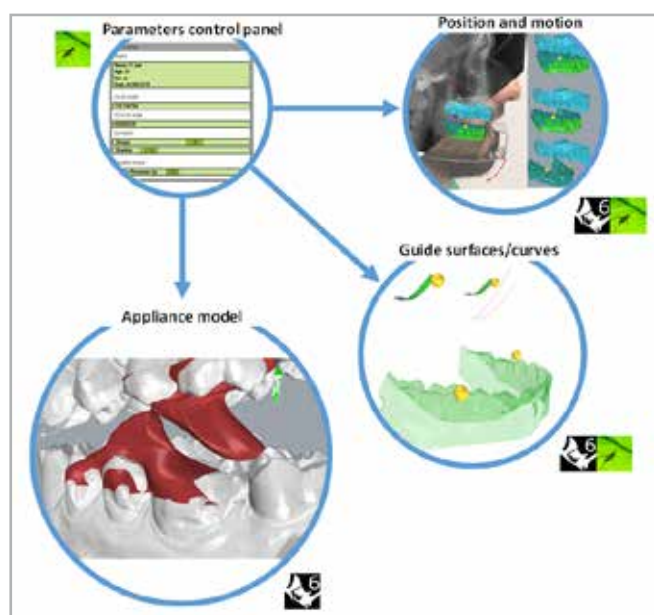

the mandible position and the right mandible motion is computed and simulated. Geometrical features such as curves and surfaces are extracted from the calculated jaw path. Based on these fundamental entities, the functional appliance is then modeled. Future work will focus on the use of 3D printing technologies for manufacturing, and on device testing.

Experience at the Research Agorà

Participation at the Research Agorà allowed us to communicate the results of our research project to a wide, competent audience. Many conference attendees were fascinated by our approach to orthodontic device design, particularly by the innovative methods used and the algorithmic strategy for simulating and correcting the motion of the jaw. CAE Conference attendees provided their personal opinions and ideas for further applications and developments, or simply identified issues with the proposed approach.

Acknowledgments

The project was partially supported by the grants "FSE 2105-51-11-2018" POR-FSE 2014-2020 from the Veneto Region of Italy.

For more information
Luca Grigolato (luca.grigolato@unipd.it) or
Gianpaolo Savio (gianpaolo.savio@unipd.it) at
the ICEA Department of the University of Padova.

POP = Performance Optimisation and Productivity - A Centre of Excellence in HPC

We were delighted to be part of the Research Agora at the 2019 International CAE Conference this year. If you attended, we hope you found the event as valuable as we did. It was great to meet so many of you and our fellow researchers in Vicenza. If we didn't get the chance to speak to you personally at the POP booth, we would like to take this opportunity now to tell you about our exciting POP project (pop-coe.eu), offering free services to improve parallel software.

About POP

HPC facilities are a major capital investment and often run close to capacity. Improving the efficiency of application software running on these facilities can either speed up time to solution or allow for larger, more challenging problems to be solved. The Performance Optimisation and Productivity (POP) Centre of Excellence exists to help you identify how your software can be improved, free of charge. Funded by the EU under the Horizon 2020 Research and Innovation Programme, POP puts the world-class HPC expertise of eight commercial and academic partners at your disposal. POP has the tools and expertise to analyse all aspects of performance from single processor efficiency to the scalability of large parallel codes. We work with programs written in most languages and parallel paradigms, including MPI, OpenMP, CUDA, OpenCL and OpenACC.

Our analysis will identify issues such as memory bottlenecks, communication inefficiencies and load imbalances. This enables a better understanding of program efficiency and the identification of target kernels for code refactoring. We can work on these computational kernels and advise how to roll out improvements to your whole application. As well as reducing run-times, greater efficiency



Your parallel code: **better**



can also lead to reduced power consumption or cloud computing costs. In the first phase of POP we investigated thirty-four codes used by a range of commercial organisations and achieved an average performance improvement over the whole application of 2.25x, i.e. on average we more than halved the time to solution.

Our experience shows that it is often difficult to build a quantitative picture of HPC application behaviour. One of the strengths of POP is our set of Metrics. They provide a standard, objective way to characterise different aspects of the performance of parallel codes. These simple measures, the performance data and recommendations are presented to you in a POP Performance Assessment report. This could be followed up by further work, again completely free to the user, to demonstrate the improvements that those recommendations would make.

Subscribe to our Newsletter, to stay up to date with POP news and developments, events and live webinar dates.

For more information: pop-coe.eu/

Follow us:

twitter.com/POP_HPC
www.linkedin.com/groups/12004488/
www.youtube.com/pophpc

For more information

Craig Lucas - Numerical Algorithms Group (NAG)
craig.lucas@nag.co.uk





1222 · 2022
800
ANNI



UNIVERSITÀ
DEGLI STUDI
DI PADOVA

Hybrid manufacturing strategies through Selective Laser Sintering for the customization of series components



The Project

Additive Manufacturing is a fully digital and automated process used to create functional end-use parts characterized by complex geometries, with reduced waste of materials and without dedicated tooling equipment. Up to today, Hybrid Manufacturing consisted of a combination of additive processes and, mainly, subtractive post-processing. The aim of the project was the development of an innovative manufacturing process for optimized mechanical parts, integrating a primary structure obtained by CNC machining with a secondary customized 3D structure obtained by additive deposition of metal powders. To develop the process, a comprehensive revision of the design-to-manufacturing methodology was done. Preliminary theoretical investigations were aimed at combining Design for AM methods and simulation-driven design approaches to develop the hybrid manufacturing process concept while enhancing product/process performances: different products were considered and virtually modelled and simulated. Different metal AM processes were investigated. In the final integration, an application for a biomedical product was developed up to the manufacturing stage: the medical device is a dental abutment adopted in implant dentistry.



The Results

The abutment consists of an upper patient-specific customized occlusal surface, a core and a bottom highly accurate hexagonal connection geometry. To manufacture the part (1), two CAD models were considered: the crown (2) and the T-base (3). T-bases were CNC turned (4). Then they were inserted into a dedicated plate with threaded connection fixtures (5-6-7). This assembly was then mounted on the SLS apparatus where the deposition and melting of the metal powder took place (8): the hybrid abutment was finally obtained (9).

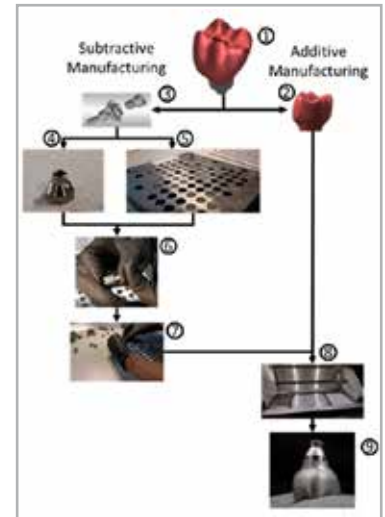

Experience at the Agorà

The participation at the Research Agorà, during the CAE Conference 2019, provided the chance to discuss the work with people from both the academic and industrial worlds, facilitating the development of new ideas to improve the technology and the investigation of new fields of application. The people that visited the booth expressed curiosity about the presented topic and showed interest in the progress of research into new manufacturing technologies.

Acknowledgments

This project received funding from the Veneto Region POR-FSE programme under grant code 2015-37-11-2018*.

For more information
Roberto Meneghello - Università degli Studi di PD
roberto.meneghello@unipd.it



SmartBench – a SMART Industrial Safety WorkBENCH



The Project

The SmartBench research project (www.smartbench-project.it) aims at exploiting, for safety purposes, the technologies going under the name of “Industry 4.0”, which are making the new industrial revolution possible. Its overall goal is to introduce a technological change in job safety in an integrated fashion.

Different tools are synchronized to this end: networks of Acoustic Emissions (AE) sensors for continuous monitoring of the structural health of components, smart tags to manage work equipment and facilities, virtual simulation of the ageing of structures, and the industrial internet of things (IIoT) to assess the health of personnel and the proper use of protective equipment.

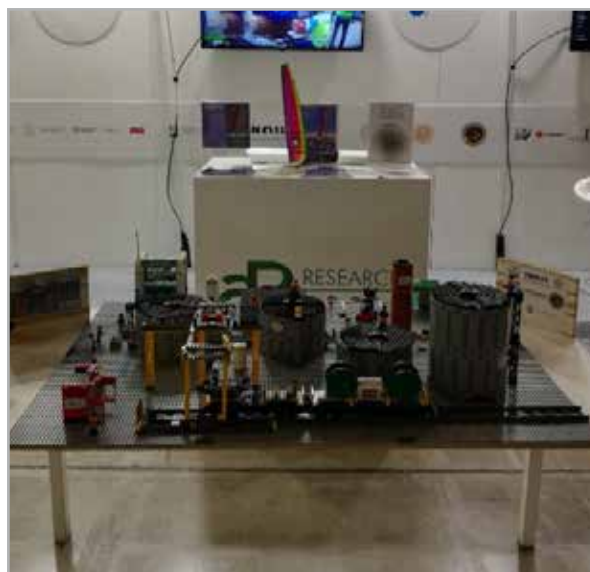

Experience at the Research Agorà

We really enjoyed the multi-disciplinary environment of the Research Agorà at the 2019 International CAE Conference. It turned out to be a stimulating environment to share the results of our efforts. Conference attendees showed interest in such a complex project, which integrates several high-tech instruments to pursue the critical and current objective of work safety. We demonstrated the workflow of a triggered maintenance operation on a small scale, using a LEGO model, to show the coordination level of the whole process to the congress attendees visiting our booth.

For more information

Marco Evangelos Biancolini
 Università di Roma Tor Vergata
biancolini@ing.uniroma2.it

A 'PLUG & PRODUCE' SOLUTION FOR DIGITAL MANUFACTURING

WeldGalaxy – B2B Knowledge-based online platform for the Arc Welding Sector



WeldGalaxy is a B2B knowledge-based online platform designed to present EU sellers of arc welding equipment, accessories, consumables and services to the global market. The digital platform aims to enhance the visibility of the EU's arc welding products, prototypes and services, while providing innovative web-based solutions.

To achieve this, WeldGalaxy incorporates a knowledge-based engineering (KBE) tool to help streamline the process of selecting the relevant technologies by the end-users. This will create a 'plug and produce' digital manufacturing service to meet the specified requirements of customers, while maintaining regulatory compliance.

The WeldGalaxy Vision

WeldGalaxy leverages advances in digital manufacturing and the application of Industry 4.0 to increase the visibility of EU

manufacturers and support the digitization of manufacturing. The aim is to enhance experimentation and market uptake of off-the-shelf prototypes delivered by EU SMEs and boost the competitiveness and market share of European welding equipment, consumables and services.

Connecting manufacturers with end-users is just one facet of WeldGalaxy as the platform will also allow support for rapid digital design and testing for innovative new equipment in collaboration with other manufacturers and end-users.

WeldGalaxy Benefits

Aside from the evident benefits of joining manufacturers with end-users, WeldGalaxy will also help to limit failures and downtime, enhance health, safety and energy efficiency, and increase productivity while reducing operating costs. This will all be





achieved through transparency of product features, capabilities, resource use, add-on services and cost.

With real-time user feedback, the platform will allow manufacturers to address any issues and meet the needs of customers.

In addition, technological development and manufacturing application domains will be fully scalable and information about standards, security and regulatory compliance will be provided.

WeldGalaxy Systems and Services

WeldGalaxy's digital B2B platform is empowered by the Dynamic Knowledge Management (DKM) platform and has an evolving database with relevant data from arc welding equipment and consumables manufacturers that dynamically evolves as the use of the database increases.

By capturing product and process knowledge, businesses are able to rapidly develop products. This knowledge-based engineering system allows both designers / manufacturers and customers to visualize and analyze the design process with the help of simulation tools and life-cycle cost analysis.

WeldGalaxy will allow arc welding processes to be simulated using a set of templates and heat source models.

The platform will connect the European welding industry to a digital single market using distributed ledger technology, to allow



updates to be implemented from across the array of users. This is the first time that advanced digital inclusion technology has been used in welding.

The access to information will be facilitated through the development of a chatbot to aid functionality.

Finally, the project will involve financial support to third parties, selecting 25 experiments through two open innovation calls.

WeldGalaxy at the CAE Conference

During the 2019 International CAE Conference, WeldGalaxy was proud to have a stand in the Research Agorà section of the CAE Conference in Vicenza, Italy. The CAE team assisted in setting up the booth, after which Geoff Melton, Technology Manager for Arc Processes and Welding Engineering at TWI Ltd. and Espen Kon,

CEO of EKON Modeling Software Systems Ltd. presented the first iteration of the WeldGalaxy project results.

During the two day-exhibition, a video was broadcast on a large screen to present the WeldGalaxy Platform and its uniqueness to the welding sector (See YouTube link: <https://youtu.be/bGe-Fc7Kbws>).

Both partners demonstrated the WeldGalaxy Platform's easiness to browse from desktop and mobile.

At the manufacturing session during the second day of the Conference, both Melton and Kon presented the WeldGalaxy project to a good-size audience and answered many interesting questions about the project.

The WeldGalaxy project has received funding from the European Union's Horizon 2020 research and innovation programme under grant agreement No. 822106. For further information, visit www.weldgalaxy.eu and follow us on <https://www.linkedin.com/in/weldgalaxy/>.

For more information

Espen Kon

EKON Modeling Software Systems

espen.kon@ekonm.com



Intelligent automatic and reconfigurable robots for quality control



SPIRIT aims to develop an “inspection skill” for robots that takes the step from programming complex inspection tasks to configuring such tasks. This will substantially reduce the engineering costs for setting up inspection robots in industrial environments. The main result will be a software framework that consists of two parts: The “offline framework” manages this automatic model-based coverage planning for complex parts and various image-based inspection processes, as well as the automatic generation of robot programs. It will include a generic interface to allow the easy exchange of process models (for different inspection technologies), of the CAD model of the part (for a different type of product to be inspected), or of the work-cell model (for a different kinematic structure). The generic “inline framework” maps sensor data to transfer 2D image data to the 3D object model. It will provide the backbone for real-time execution of the actual inspection process, including the synchronization of data acquisition and robot motion.



This project has received funding from the European Union’s Horizon 2020 research and innovation programme under grant agreement No. 779431.

For more information, visit: <http://spirit-h2020.eu/>



For more information
Mattia Vincenzi - IT+Robotics
mattia.vincenzi@it-robotics.it



Three big projects for SME Innovation



Veneto Innovazione was present at the 2019 International CAE Conference and Exhibition held in Vicenza on 28-29 October. In the Research Agorà, it presented KETGATE, Innopeer AVM and EEN, its most important initiatives that focus on innovation and business improvement for SMEs.

Veneto Innovazione is one of the KETGATE partners, an Interreg Central Europe project that connects business support organizations (BSOs) and research institutes (RTOs). It is a network that helps SMEs to access high-level technology for advanced materials, photonics and micro- and nano-electronics in the areas of transport, health and food.

The KETGATE booth was visited by companies asking about the services to carry out innovation projects using key enabling technologies through the central European network of RTOs and BSOs. InnopeerAVM is another Interreg Central Europe project that includes Veneto Innovazione as one of its partners. It develops and tests a first comprehensive and transnational AVM qualification programme, adapted to the needs of companies.

At the 2019 CAE Conference, companies visited the Veneto Innovazione booth to ask about the possibility to improve through

the Innopeer AVM qualification programme. In particular, they wanted to know more about the training course “TOWARDS INDUSTRY 4.0: Technology, Organization and Strategy” organized by Veneto Innovazione in November 2019. Veneto Innovazione is also the Veneto regional reference of EEN, the Enterprise Europe Network, the leading technology transfer network in the world.

It brings together business advisers from more than 600 network member organizations from more than 60 countries, as well as representatives from the European Institutions and key external stakeholders.

In the Research Agorà, Veneto Innovazione explained to companies how EEN can help them to describe their technological needs in a standardised way and search for the best solutions on the market. The network can increase competitiveness and internationally promote innovative technologies and know-how developed by companies and research organisations in the Veneto region.

For more information

Francesca Maccatrozzo - Veneto Innovazione
francesca.maccatrozzo@venetoinnovazione.it



Growing life outside planet Earth

MELiSSA Program's PaCMan project leads to the creation of a Plant Control Unit to study plants for use in long-term space missions



EnginSoft has signed and concluded a contract with the European Space Agency (ESA) to design, engineer and build a pilot laboratory to grow plants for space applications. A long period of research featuring considerable investments from the European Space Agency (ESA), supported by Agenzia Spaziale Italiana (ASI – the Italian Space Agency), has finally borne fruit with the production of the Plant Control Unit (PCU) financed by the PaCMan project (PIAnt Characterization unit for closed life support system – engineering, MANufacturing and testing). The PCU will be the core of the first laboratory dedicated to the research of plant growth in space. The PCU chamber is located in the research facility of the Department of Agriculture of the University of Naples “Federico II” in its lovely surroundings in the Reggia di Portici (the Royal Palace of Portici) near Naples.

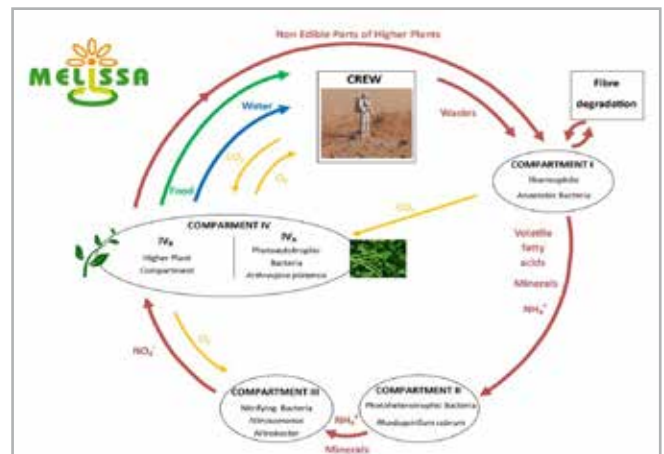

Fig. 1 - The MELiSSA Loop

MELiSSA Program

The PCU was engineered by EnginSoft and its partners in the PaCMan project, which is the latest in a long collaboration with ESA in the MELiSSA (Micro–Ecological –Life Support System Alternative) research program. The primary mission of MELiSSA is to recover food, water and oxygen from organic carbon dioxide and mineral waste, using light as an energy source to promote biological photosynthesis. It is based on the principle of an “aquatic” lake ecosystem in which waste products are processed



Fig. 2 - The EDEN Laboratory in Antarctica

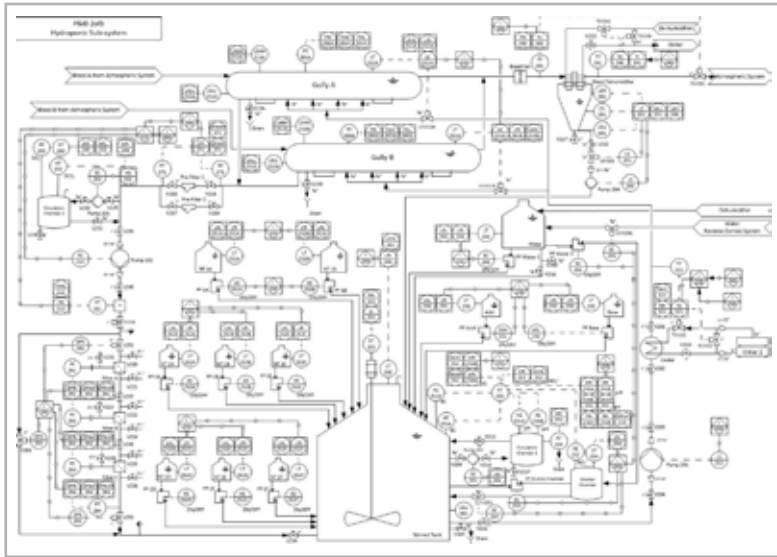

Fig. 3 - The P&ID Hydroponic system for the PCU

using the metabolism of plants and algae which, in turn, provide food, air revitalization and water purification. This closed-loop concept will ultimately be able to support life in long-term space missions, such as the lunar base or the mission to Mars.

EnginSoft Aerospace

EnginSoft is present in numerous nationally and internationally funded research programs, and has also worked actively in space research with DLR and Thales Alenia. In particular, the collaboration with DLR in the EDEN ISS project has led to the development of the plants that are being used for scientific research on vegetables in Antarctica.

EnginSoft now has a ten-year collaboration with ESA and is honored to be a member of the MELiSSa program, participating in the frontline development of engineering and research activities as a prime contractor and coordinator in numerous research projects, such as:

- HySSE – HYdroponic SubSystem Engineering
- AtSSE – ATmospheric SubSystem Engineering
- PaCMan - PIAnt Characterization unit for closed life support system – engineering, MANufacturing & testing

PaCMan

An international team of scientists and engineers coordinated by Dr. Lorenzo Bucchieri and his team have addressed several technological challenges with PaCMan. The team includes experts from:

- The United Kingdom - Hosokawa Ltd, experts in gas-tight sealing systems
- Norway – CiRIS, experts in advanced hydroponic sensors
- Italy - Odys, experts in control systems
- Italy - the University of Naples “Federico II”’s Department of Agriculture, experts in plant physiology

PaCMan Technology

The PCU or growth chamber for plant growth is certainly state-of-the-art in this field of application and will allow Italian science to take a leap forward in researching plants for space missions. The rate of leakage is minimal and close to zero, thanks to the advanced gas-tight sealing system that has been developed, which will allow highly accurate measurements to be taken relative to the mass balances of the plants (discerning the atmosphere from the hydroponics) that determine the production of oxygen for the life support of the astronauts, among the various biochemical processes.

In fact, the regeneration of resources has to be guaranteed with the minimum waste of energy and materials. Plants with roots, stem and leaves (“superior plants”), are an excellent means of ensuring air regeneration through photosynthesis, water purification through transpiration, and the recycling some of the crew’s waste products as a source of nutrients for the plant’s hydroponic system, while providing oxygen and fresh food to supplement the astronauts’ diet.

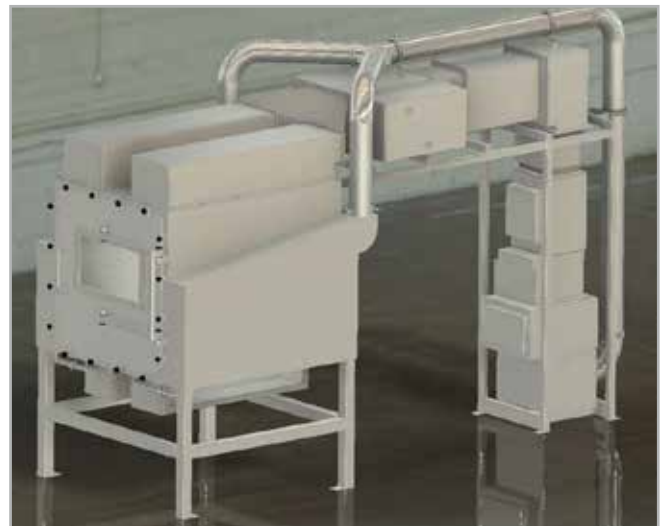

Fig. 4 - The PCU – Design

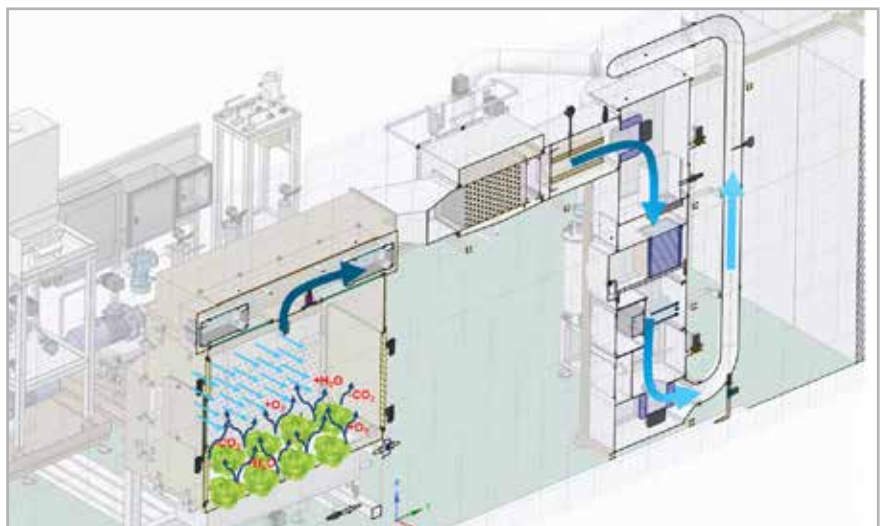

Fig. 5 - PCU – Functionality



Fig. 6 - PCU – Manufactured

Finally, its sophisticated scientific sensors will allow the study, understanding and measurement of plant growth parameters, such as minerals and concentrations in the nutrient solution, while a novel filtering system will ensure the reliability of the measurements in the hydroponic system without bio-fouling.

Doctor Bucchieri stated: *"I've been working in aerospace research for about 30 years, starting with the fire suppression system on*

the Columbus module for the ISS, up to the satisfactory collaboration with ESA today. I am very proud and happy to be part of MELiSSA and to have received the trust and the empowerment from ESA to coordinate the development of the projects that ultimately led to the construction of this growth chamber in the research facility of Portici." He concluded, *"Special thanks to Christophe Lasseur and Christel Paille of ESA who lead the MELiSSA consortium and who have entrusted me and EnginSoft with the power to direct all the projects that have led us to the PaCMAN unit. I would also like to acknowledge Claudia Quadri and Sebastian Colleoni from the*

EnginSoft team, who have brilliantly dedicated their skill and know-how to make this project a success."

For more information

Lorenzo Bucchieri - EnginSoft

l.bucchieri@enginsoft.com

Whiteready: providing internet security since 1998



Vulnerability assessment, disaster recovery planning, business continuity services, and cyber-attack simulations plus regular Internet services

Since 1998, Whiteready has been providing strength and protection to your Internet presence with network services, internet operations, hosting, housing and colocation services, virtual machines and virtual private servers. From the very first day of its operation, Whiteready's security was not simple a collateral service that it offered to customers, but rather the cornerstone of its Internet presence, thanks to its data centers in Italy and the United Kingdom. Whether you host a small business site, an e-commerce portal or advanced cloud services, with Whiteready you can be sure of real personalized support: no robots, bots or automated chats, but rather professionals able to respond promptly to your requests.

Whiteready is able to guarantee the essential functions of the business, ensuring business continuity and safeguarding the reputation of the company. As a preventative measure, Whiteready identifies the events that can potentially compromise the regular flow of operations, thereby reducing the significant risks of disruptions or external intrusions, and configuring a suitable infrastructure to enable rapid intervention if necessary.

The service provider is able to detect the presence of weak points in corporate hosts through systems analysis, service registration and the verification of published vulnerability databases. Vulnerability Assessment can be applied to different domains: network infrastructure and equipment, wireless, systems (servers with different Microsoft- or Unix-like operating systems), or applications (eg. web applications, application servers, etc.). Vulnerability detection involves a phase of pre-authorized cyber-attack simulations to experience and prepare for a real potential attack.

Whiteready can predict the impact of an attack on a corporate network, accurately mapping internal processes and flows to identify weaknesses, and define recovery times and the resources required to restore normality. In the event of an attack, Whiteready immediately implements a business continuity plan (BCP), indicating the steps that led to the event and restoring the pre-existing condition to the highest possible level. In extremely critical situations, such as data center fires, cyber or ransomware attacks, Whiteready prepares an IT systems recovery plan or disaster recovery plan (DRP).

For more information

Luisa Bruna Caprotti - Whiteready

lcaprotti@whiteready.com

ANSYS Fluent and Particleworks air-liquid coupling simulation is available now



By Akiko Kondoh
Prometech Software, Inc

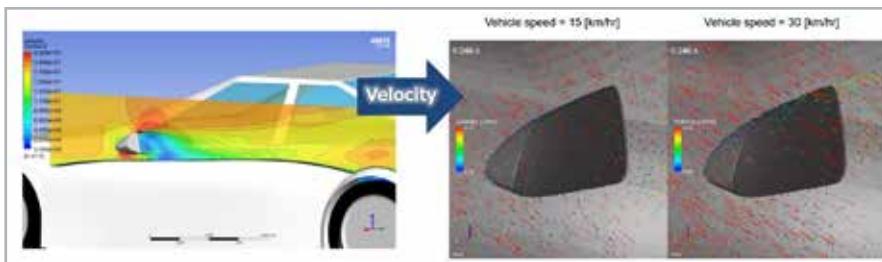

Fig. 1 - Behavior analysis of raindrops around side mirrors

Particleworks, a mesh-free liquid-flow simulation software based on the moving particle simulation (MPS) method, has been introduced mainly in the automotive industry and other various fields all over the world. The demand to couple such liquid behavior simulation with other physical phenomena such as structure, heat, and airflow has increased recently, because it would enable more realistic design verifications that are much closer to the actual products' behavior.

In July 2019, Particleworks for ANSYS 1.0 was released to meet this demand. This interface product for ANSYS provides a fast, specialized simulation tool that performs liquid flow simulations with large free-surface deformation, complementing Fluent's high-resolution, high-accuracy free-surface results. It allows Particleworks to be used in the ANSYS Workbench environment exploiting ANSYS' simulation capabilities for more realistic product design evaluations. Version 1.0 adds coupling with structure enabling structural deformation calculations by fluid pressure and thermal

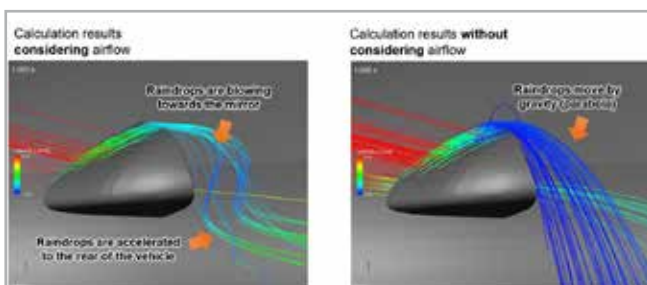

Fig. 2 Raindrop behaviors considering airflow (left) and without considering airflow (right)

stress calculation using heat transfer coefficient. The newly released Particleworks for ANSYS 1.1 has been upgraded with the capability to perform liquid simulations that consider the effect of airflow calculated by ANSYS Fluent (thermal fluid simulation software).

Figs. 1 and 2 show an airflow simulation around a car's side mirrors using ANSYS Fluent, and the simulation of the behavior of raindrops, both using Particleworks to consider the effect of the airflow. If airflow is not taken into account, raindrops move only by gravity, in which case the streamline draws a parabola. When considering the airflow

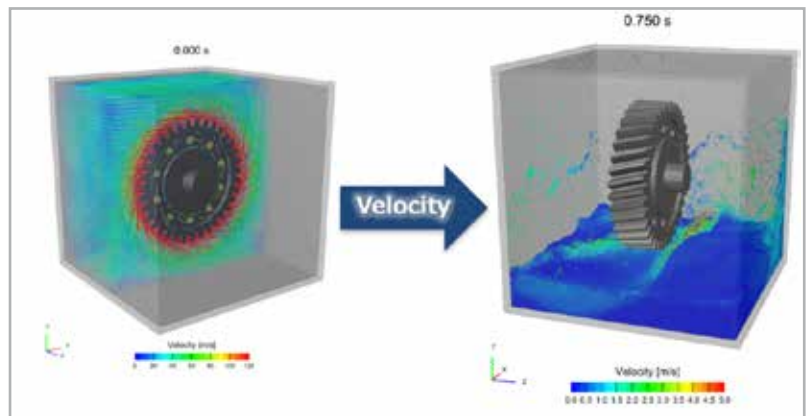
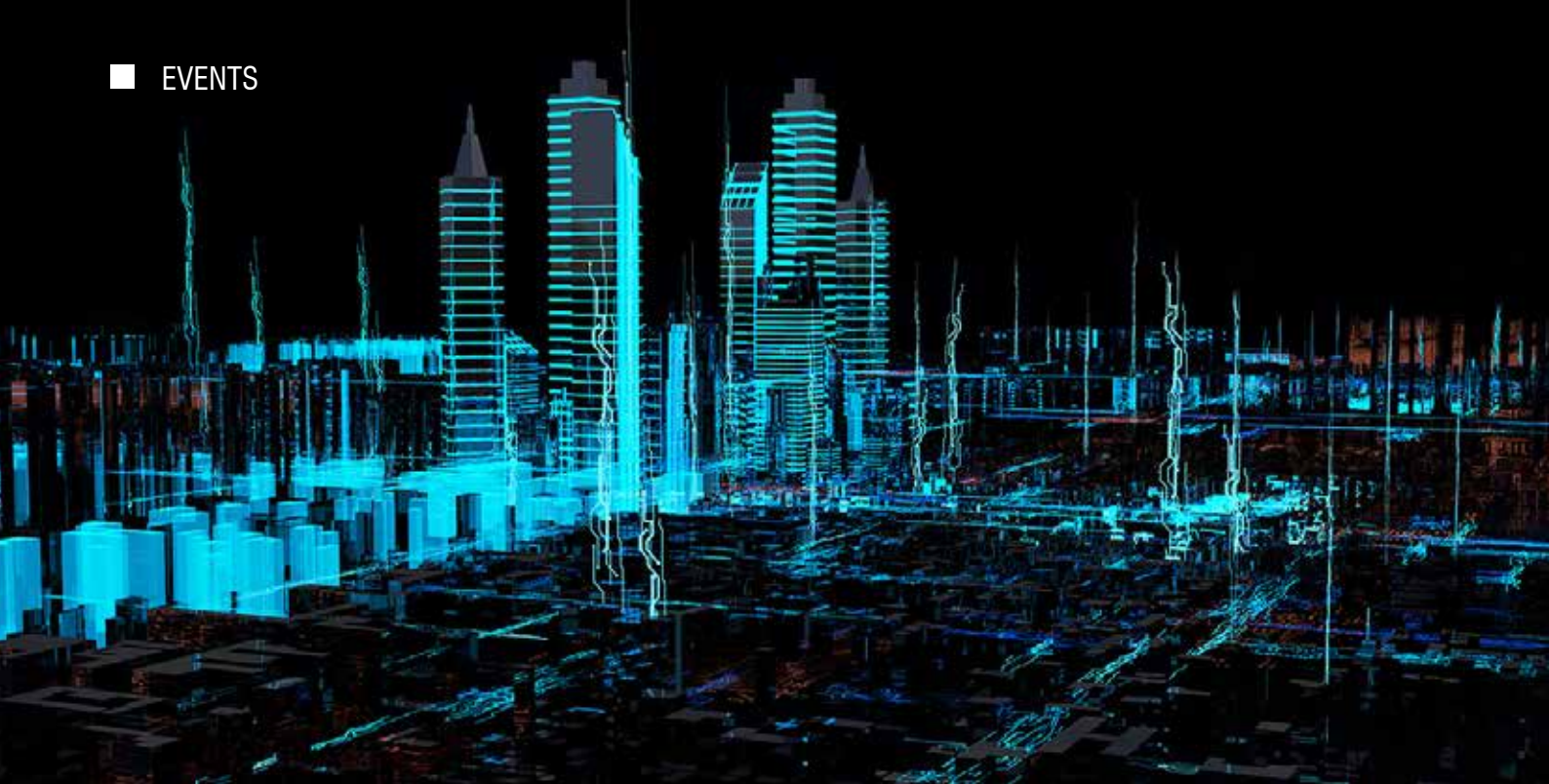

Fig. 3 - Oil lubrication analysis when the gear is idle

effect, the physically realistic behavior of the raindrops caused both by gravity and the airflow around the side mirrors can be reproduced.

The coupling of ANSYS Fluent and Particleworks in the Workbench environment can promote the evaluation and understanding of fluid dynamics behaviors in the design and development processes to enhance future competitiveness.

For more information
Massimo Galbiati - Particleworks EUROPE
m.galbiati@engisoft.com



Digital Twins support the security management of Critical Infrastructures

CRISR event with EnginSoft demonstrates how System Simulation can monitor, track and predict the behavior of complex systems

The “Hands on Cyber - Physical threats to Critical Infrastructures” Summer School was held in Lecce in September. The event was targeted at “next-generation” security managers with the aim of connecting participants with the real world of the security management of critical infrastructures. Critical infrastructures are a country’s strategic systems and resources whose failure would have a devastating impact on the national economy, public health or on national security.

The event was organized by the Centre for Interdisciplinary Research on Security and Resilience of Critical Infrastructures (CRISR), sponsored by Snam and supported by EnginSoft.

Simulation-based digital twins applied to this issue are on the rise year by year and EnginSoft provided a class on the use cases and future prospects for numerical simulation in the security of critical infrastructure.

Numerical simulation and the security of critical infrastructure: the natural path to improving resilience

The functionality and security of a country are often related to its socio-economics activities, such as the transport of goods, communications or the supply of electricity and water. These activities need to be supported by an extensive network of people,

information, physical resources and more. This complex system has been defined as Critical Infrastructure (CI) and it is the backbone upon which national and/or international frameworks are built.

In the last 20 years, the threat of terrorism has highlighted both the vulnerability of these systems and their deep interdependencies. That is why CIs are now defined and protected by national and supranational laws and regulations. The security of the CI is not defined in terms of a static image. Contexts and boundaries conditions change dynamically over the years. Hence, the approach and the metrics for measuring CI security have to reflect these changes.



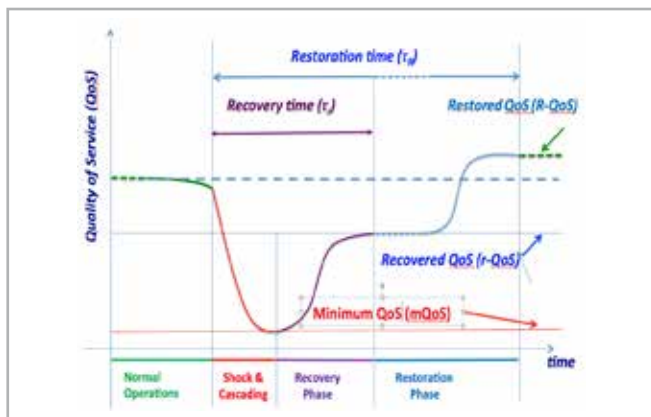

In fact, today one cannot only consider the functionality of the system, but one must also consider its ability to recover. This capacity is called “resilience” and has become a mandatory requirement for any critical infrastructure in Europe (see Directive 114/08/EC).

In general, the resilience of a critical infrastructure system is a quality that reduces vulnerability, minimizes the consequences of threats, accelerates response and recovery, and facilitates adaptation to a disruptive event.

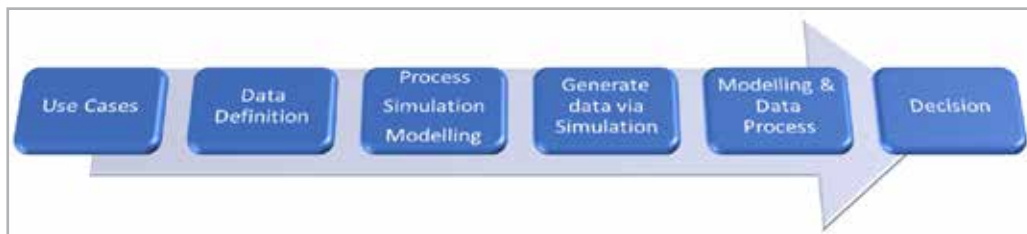

Improving the resilience of their CIs is a challenge for all countries in the world. New technologies and methodologies are now playing an important role in executing this task and simulation is among them. In fact, the availability of a large amount of data from surveillance systems, sensors, drones, and more, paired with the growth of computing power has opened up opportunities that were unthinkable a few years ago.

In fact, whereas in the past simulation tools were mainly used for design and validation, today the conjunction between the evolution of technology and the availability of big data makes a new type of simulation possible. By using the concept of system simulation, engineers can monitor, track and predict the behavior of complex systems such as critical infrastructures.

System simulation essentially involves combining the models for predicting the performance of the various system components into a comprehensive procedure. A major advantage of this method is that it allows the interconnections among the components and how they affect each other to be considered.

The digital twin paradigm provides a natural opportunity to create an effective methodology, as well as the processes and systems to verify and increase the resilience of the CI: to identify dangerous scenarios, perform specific actions, and forecast the systems’ response in order to evaluate beforehand how the CI would react to each individual threat.

How does it work?

The first step is a risk assessment to define the real threat to the CI and the likelihood of its occurrence; each threat (physical or cyber) should be matched to one or more parameters that are monitored by sensors or other data sources.

All the collected datasets constitute the input to the system model of the critical infrastructure. Through system simulations and predictive models, it is then possible to understand the behavior of the system itself and its response to a critical event.

The simulation-based digital twin can become the key enabler to improving the critical infrastructure’s resilience: starting from the estimated effects of a critical scenario to the identification of reliable and secure operations, numerical simulation can suggest the best solution for the monitoring parameters, use them to replicate the system’s behavior, forecast its response and support the decision-making process.

Moreover, the continuous monitoring, control and management of the security of these infrastructures is facilitated by an efficient bridging of the physical asset with its digital counterpart: policy procedures, operational

plans, systems of people and devices can be connected to ensure the continued operation of critical infrastructure in the face of all dangers. Some examples of this approach can be seen in the work of big players such as GE, Ansaldo Energia, Eni and many others that are developing digital twin applications along their path of digital transformation.

The use of these tools improves asset productivity, efficiency and safety and can become a great support for the security management of critical infrastructures.



For more information
 Mariarita De Rinaldis - EnginSoft
m.derinaldis@enginsoft.com

35th INTERNATIONAL CAE CONFERENCE AND EXHIBITION



**THE ENGINEERING SIMULATION PATH
TO DIGITAL TRANSFORMATION**

**Proceedings, protagonists
and salient moments of the 2019 edition
proceedings2019.caeconference.com**

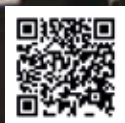

www.caeconference.com